

CiA Draft Standard Proposal 412



Profiles for medical devices

Part 2: Automatic X-ray collimator

This is a draft standard proposal and may be changed without notification

Version 1.0

25 May 2003

© CAN in Automation (CiA) e. V.

HISTORY

Date	Changes
25.05. 2003	<i>Publication of Version 1.0</i>

CONTENTS

1	Scope	5
2	Normative references	5
3	General architectural principles	5
4	Operating principle of a generic X-ray collimator	5
4.1	Definitions	6
4.2	Generic collimator coordinate system	7
4.3	Calibration functions.....	8
4.4	Local control	8
4.5	Position and velocity modes	8
4.5.1	Position mode	8
4.5.2	Velocity mode.....	8
5	Error handling	9
5.1	Error classification	9
5.2	Emergency object usage	9
5.2.1	Error code.....	9
5.2.2	Error number	9
6	Predefinitions	10
6.1	Generic command value definition for collimator sets.....	10
6.2	Complex data type definition	11
6.2.1	Record 80 _h : x_y_parameter_set.....	11
6.2.2	Record 81 _h : s_ω_parameter_set.....	12
6.2.3	Record 82 _h : D_parameter_set.....	13
6.3	Pre-defined communication objects	13
6.4	Default RPDO communication and mapping parameter	13
6.5	Default TPDO communication and mapping parameters.....	13
7	Collimator object dictionary	14
7.1	Overview	14
7.2	6000 _h : Source image distance (SID).....	14
7.3	6001 _h : Source fringe distance (SFD).....	15
7.4	6002 _h : Collimator command.....	15
7.5	6003 _h : Collimator state.....	16
7.6	6010 _h to 601F _h : Symmetric rectangular collimation set n (SRCS).....	17
7.7	6020 _h to 602F _h : Quadrangle collimation set n (QCS).....	22
7.7.1	6020 _h : Quadrangle collimation set 1 side 1 (QCS).....	24
7.7.2	6021 _h to 6023 _h : Quadrangle collimation set 1 side 2 to 4 (QCS)	29
7.7.3	6024 _h to 602F _h : Quadrangle collimation set n side 1 to 4 (QCS)	29
7.8	6030 _h to 603F _h : Circular collimation set n (CCS).....	30
7.9	Collimator filter functionality	33
7.9.1	6040 _h to 604F _h : Homogeneous filter set n (HFS).....	33

7.9.2	Spatial filters.....	36
7.10	X-ray visualisation functionality.....	42
7.10.1	6100 _h : Visualisation control (VC).....	42
7.10.2	6101 _h : Visualisation state (VS).....	43
8	Finite state automata (FSA).....	44
8.1	Introduction to the finite state automata	44
8.2	The collimator FSA.....	44
8.2.1	The states of the collimator FSA.....	44
8.2.2	The events of the collimator FSA.....	46
8.2.3	The transitions of the collimator FSA.....	47
8.3	The coordinate FSA	47
8.3.1	The states of the coordinate FSA.....	47
8.3.2	The events of the coordinate FSA.....	49
8.3.3	The transitions of the coordinate FSA.....	50
8.4	The homogeneous-filter-set FSA.....	50
8.4.1	The states of the homogeneous filter FSA	50
8.4.2	The events of the homogeneous filter FSA	51
8.4.3	The transitions of the homogeneous filter FSA	52
8.5	The X-ray visualisation FSA	53
8.5.1	The states of the X-ray visualisation FSA.....	53
8.5.2	The events of the X-ray visualisation FSA.....	54
8.5.3	The transitions of the X-ray visualisation FSA.....	54
9	Appendix.....	54
9.1	Collimator swivel	54
9.2	SID measurement	54
9.3	Patient area dose rate measurement.....	55
9.4	Use case scenarios	55
9.4.1	Definitions.....	55
9.4.2	Use case: Coordinate motion between the defined limits.....	56
9.4.3	Use case: Changes in the value of SID	58
9.5	Coordinate systems for quadrangular collimation and spatial filters	61

1 Scope

This document represents the CANopen device profile for generic X-ray collimators, and as such describes the generic subset of collimator functionality.

A prerequisite for the conformity to this CANopen device profile is conformity with the CANopen communication profile (CiA Draft Standard DS 301). Additionally, in the case that the module is programmable it must conform to the Framework for programmable CANopen devices (CiA Draft Standard Proposal DSP 302). These specifications should be consulted in parallel to this device profile specification.

2 Normative references

- /1/ CiA DS 301 V4.02: CANopen application layer and communication profile (February 2002)
- /2/ CiA DSP 302 V3.2.1: Framework for programmable CANopen devices (April 2003)
- /3/ CiA DS 401 V2.1: CANopen device profile for generic I/O modules (May 2002)
- /4/ CiA DSP 412-1 V1.0: CANopen profiles for medical devices – Part 1: General definitions (January 2003)

3 General architectural principles

The guiding architectural principles used in defining the generic collimator device profile are:

- The collimator has no application knowledge
- The collimator has no system knowledge
- The system has no knowledge of the collimator device implementation

It is the objective of this device profile to minimize the number of violations of these guiding principles.

4 Operating principle of a generic X-ray collimator

The generic collimator, as defined by this device profile, has three basic functions, which may or may not be implemented in a specific collimator:

1. The main-purpose of a collimator is limiting (or collimating) the X-ray beam issued by an X-ray emitting source (X-ray tube) to a defined (receptor) format. This specification supports several versions of this collimation function, of which rectangular collimation is the most common.
2. In addition, filters may be applied to the X-ray beam in order to influence spectral characteristics of the X-ray beam.
3. Finally, visual simulation of the X-ray beam is functionality incorporated in this device profile.

It should be noted that manufacturer-specific functionality might be added to the generic collimator functionality. This functionality does not form part of this generic standard and shall be described in the manufacturer's documentation. It shall not affect the operation of the functionality described in this document.

4.1 Definitions

Term	Abbreviation	Description
Central Collimator Axis	-	Line perpendicular to collimator entrance plane, whereby the point of intersection defines the origin of the Collimator Entrance Plane ($X = 0, Y = 0$)
Collimator Entrance Plane	-	Two-dimensional generic collimator plane defined by the collimator manufacturer.
Finite State Automaton	FSA	This is an abstraction to describe the behavior of a black box as it can be experienced by external actors
Image Receptor Reference Plane	-	The plane parallel to collimator entrance plane and located at a distance SID from the X-ray focus. All (geometric) collimator parameters are defined in this plane. There is one exception to this rule: the minimum and maximum physical positions (limits) are defined at an SID value of 1m. <i>Note:</i> The real image receptor plane is not known to the collimator (see guiding principles), hence the introduction of the image receptor reference plane
Power-On Self-Test	POST	Self-test of the CANopen device after power-on
Region of Interest	ROI	Defines area in the image receptor reference plane which is to be radiated
Source Image Distance	SID	The distance between the X-ray focus and the Image Receptor Reference Plane.
Source Fringe Distance	SFD	The distance between the X-ray focus and the Collimator Entrance Plane <i>Note:</i> The SFD is located on the z-axis (coordinate system is defined later in this document)
Spatial Filter Reference Line	-	Reference line used to define the position (s, ω) of the spatial filter in the Image Receptor Reference Plane. The position of Spatial Filter Reference Line with respect to the physical spatial filter is collimator dependent and therefore defined in the corresponding collimator documentation.
System	-	The medical X-ray equipment of which the collimator is a component
X-ray Visualisation	-	The mechanism used to simulate the X-ray beam

4.2 Generic collimator coordinate system

The collimator coordinate system is defined as follows and is shown schematically in *fig. 1*.

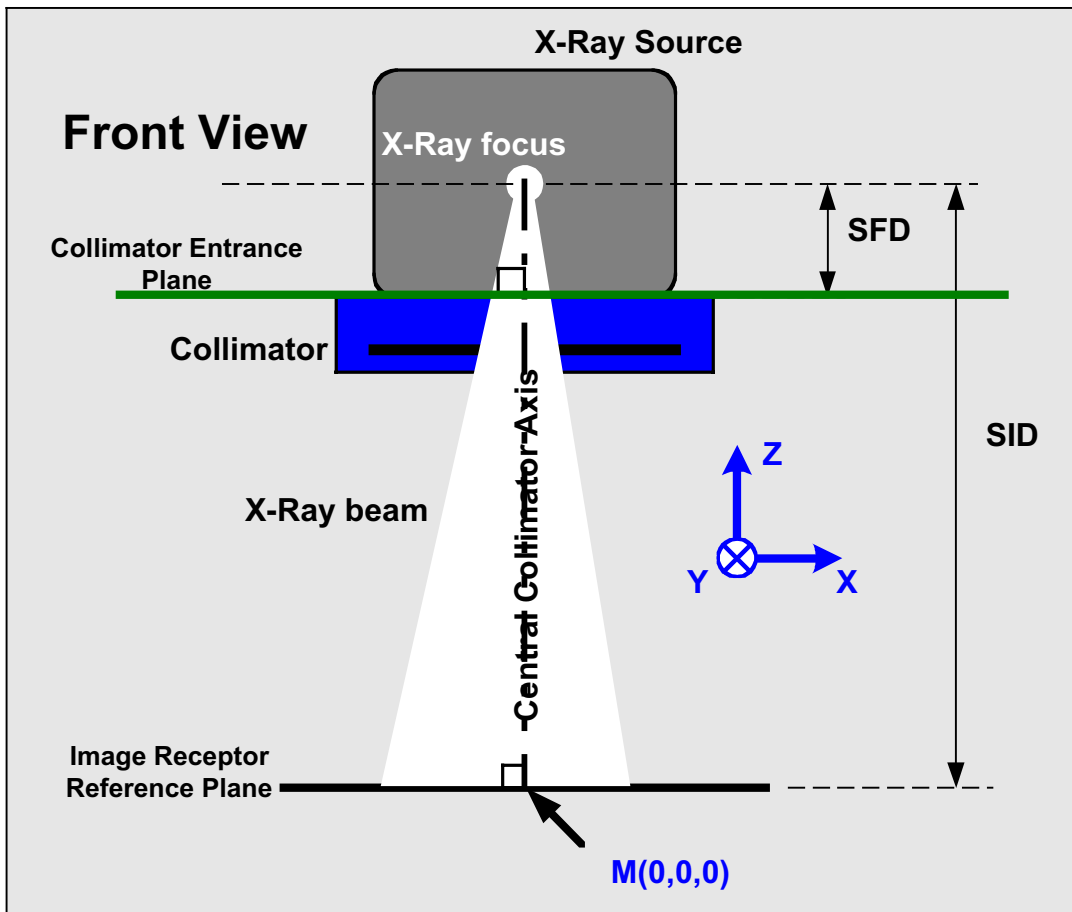

Fig. 1: Collimator coordinate system, whereby the individual coordinates are as seen from a front view

Note: Fig. 1 assumes that the X-ray focus is located on the Central Collimator Axis. Should this not be the case, then the System is responsible for providing means for correcting this misalignment. The necessary measures are implementation dependent and go beyond the scope of this device profile. (The correction of) the misalignment only affects the performance of the collimator not the functionality.

The coordinate system is derived as follows:

- Collimator Entrance Plane
Generic collimator plane defined by the collimator manufacturer.
- The Central Collimator Axis crosses the Collimator Entrance Plane perpendicularly. The intersection point ($X = 0, Y = 0$) is defined by the collimator manufacturer.
- The Image Receptor Reference Plane
is defined to be parallel to the Collimator Entrance Plane and located at a distance SID from the X-ray focus. The intersection of the Image Receptor Reference Plane and the Central Collimator Axis is the origin, $M(0, 0, 0)$, of the coordinate system.

Z is the Central Collimator Axis, whose origin is at the intersection of the Central Collimator Axis and the Image Receptor Reference Plane, positive increasing moving towards the X-ray focus.

X, Y are perpendicular to Z-axis, perpendicular to each other. Their respective origins are at the intersection point between the Central Collimator Axis and the Image Receptor Reference Plane.

X, Y, Z - form a right-handed Cartesian coordinate system with origin M.

The angle alpha in the x-y plane is positive increasing from positive X to positive Y.

4.3 Calibration functions

No specific calibration functions are defined in this device profile.

4.4 Local control

Some automatic X-ray collimators may also be equipped with local control functionality, whereby collimator functionality can be controlled locally without a transmission of command telegrams via the CAN bus. The reader of this device profile should therefore be aware, that local control functionality may result in collimator internal events affecting the functionality of the collimator.

The following figure demonstrates the presence of a local control functionality:

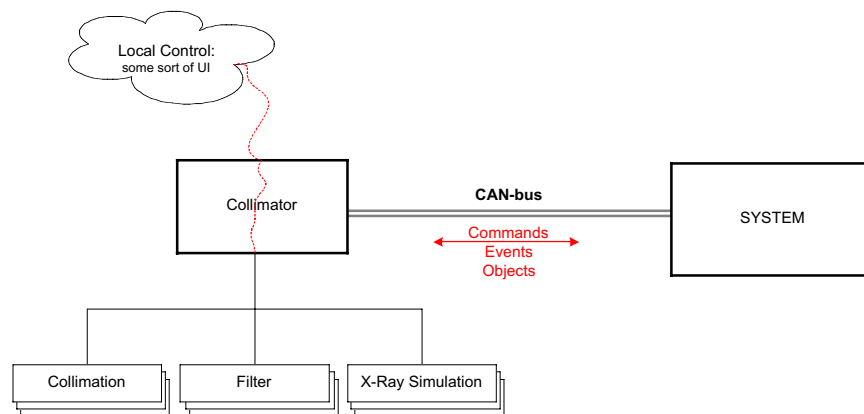

Figure 2: Automatic X-ray collimator with local control functionality

4.5 Position and velocity modes

The collimator functionality coordinates (X, Y, s, ω , D) as defined in this device profile, may be controlled either in *Position* or *Velocity* mode.

Note: The *position* or respectively *velocity* modes are not visible in the finite state automata defined in this device profile.

4.5.1 Position mode

A coordinate is in *position* mode, when it receives a new `target_position`. The coordinate is then moved to the target position with the maximum velocity as defined for this coordinate (collimator specific).

Note: While in *position* mode the value of the object “`target_velocity`” for the corresponding coordinate is ignored.

4.5.2 Velocity mode

A coordinate is in *velocity* mode, when it receives a new `target_velocity`. The coordinate is then moved at the requested `target_velocity` in the direction given by the sign of the `target_velocity` value (“-“ negative direction, “+” for positive direction).

Note: While in *velocity* mode, the value of the object “target_position” for the corresponding coordinate is ignored.

5 Error handling

5.1 Error classification

Device errors are classified into three categories:

Error classification	Value	Description/consequences
Warning	0	Operation of the collimator is not influenced
Recoverable	1	The operation of the collimator may to some extent be inhibited.
Non-Recoverable	2	A serious error has occurred. The system must decide whether X-ray operation should be disabled.

5.2 Emergency object usage

General definitions are given in /4/. The Emergency telegram data structure (8 byte) for automatic X-ray collimators shall be as follows:

Byte 0 to Byte 1	Byte 2	Byte 3	Byte 4	Byte 5 to Byte 7
Error code See table of error codes in 5.1.1	Error register Object 1001 _h (defined in /1/)	Error classification 0 = Warning 1 = Recoverable 2 = Non-Recoverable	Error number	Manufacturer-specific

5.2.1 Error code

The following error codes are specified for devices governed by automatic X-ray collimators:

Error code	Meaning
F00X _h	General collimator error
F010 _h to F01F _h	Error in symmetric rectangular collimation Set 1 to 16
F020 _h to F023 _h	Error in quadrangle collimation Set 1 to 4
F030 _h to F03F _h	Error in circular collimation Set 1 to 16
F040 _h to F04F _h	Error in homogeneous filter Set 1 to 16
F050 _h to F05F _h	Error in spatial filter set 1 to 16
F060 _h	Error in X-ray visualisation
F070 _h	Power-on self-test (POST) error

5.2.2 Error number

The error number is used to further specify the error, which has occurred. It is manufacturer specific with a default value of 0_d.

6 Predefinitions

6.1 Generic command value definition for collimator sets

The collimator-sets shall use the following command value definition:

<i>Code and name</i>	<i>Function</i>	<i>Restrictions and comments</i>
0 _d : NOOP	No action, no operation	None
1 _d : LOCK	The coordinate is locked into system control	Local control is disabled *)
2 _d : UNLOCK	The coordinate is released from system control	Local control is enabled *)
3 _d : STOP	The movements of the coordinate are stopped	None
4 _d to 9 _d	Reserved for future extensions of this device profile	
10 _d to 14 _d	Manufacturer-specific	None
15 _d : RFAULT	Reset fault	When the collimator does not detect a fault, then the Error State is left

Notes:

- *) Local control is an option. When local control is not implemented, then these commands are accepted, but act as no-operation.
- When a coordinate receives a new value of an object “target_position”, then its mode becomes “position”. In this mode the object “target_velocity” is ignored.
 - When a coordinate receives a new value of an object “target_velocity”, then its mode becomes “velocity”. In this mode the object “target_position” is ignored.
 - The mode (position or velocity) is not visible in the finite state automata.

6.2 Complex data type definition

6.2.1 Record 80_h: x_y_parameter_set

Index	Sub-Index	Description	Data Type
80 _h	0 _h	Number of parameters	Unsigned8
	1 _h	Command	Unsigned8
	2 _h	Control status	Unsigned8
	3 _h	Actual position x	Unsigned16
	4 _h	Target position x	Unsigned16
	5 _h	Min position x	Unsigned16
	6 _h	Max position x	Unsigned16
	7 _h	Min physical position x	Unsigned16
	8 _h	Max physical position x	Unsigned16
	9 _h	Actual velocity x	Integer16
	A _h	Target velocity x	Integer16
	B _h	Min velocity x due to physical limits	Unsigned16
	C _h	Max velocity x due to physical limits	Unsigned16
	D _h	Actual position y	Unsigned16
	E _h	Target position y	Unsigned16
	F _h	Min position y	Unsigned16
	10 _h	Max position y	Unsigned16
11 _h	Min physical position y	Unsigned16	
12 _h	Max physical position y	Unsigned16	
13 _h	Actual velocity y	Integer16	
14 _h	Target velocity y	Integer16	
15 _h	Min velocity y due to physical limits	Unsigned16	
16 _h	Max velocity y due to physical limits	Unsigned16	

6.2.2 Record 81_h: s_ω_parameter_set

Index	Sub-Index	Description	Data Type
81 _h	0 _h	Number of parameters	Unsigned8
	1 _h	Command	Unsigned8
	2 _h	Control status	Unsigned8
	3 _h	Actual position s	Integer16
	4 _h	Target position s	Integer16
	5 _h	Min position s	Integer16
	6 _h	Max position s	Integer16
	7 _h	Min physical position s	Integer16
	8 _h	Max physical position s	Integer16
	9 _h	Actual velocity s	Integer16
	A _h	Target velocity s	Integer16
	B _h	Min velocity s due to physical limits	Unsigned16
	C _h	Max velocity s due to physical limits	Unsigned16
	D _h	Actual position ω	Integer16
	E _h	Target position ω	Integer16
	F _h	Min position ω	Integer16
	10 _h	Max position ω	Integer16
11 _h	Min physical position ω	Integer16	
12 _h	Max physical position ω	Integer16	
13 _h	Actual velocity ω	Integer16	
14 _h	Target velocity ω	Integer16	
15 _h	Min velocity ω due to physical limits	Unsigned16	
16 _h	Max velocity ω due to physical limits	Unsigned16	

6.2.3 Record 82_h: D_parameter_set

Index	Sub-Index	CirColSet Record	Data Type
82 _h	0 _h	Number of parameters	Unsigned8
	1 _h	Command	Unsigned8
	2 _h	Control status	Unsigned8
	3 _h	Actual position D	Unsigned16
	4 _h	Target position D	Unsigned16
	5 _h	Min position D	Unsigned16
	6 _h	Max position D	Unsigned16
	7 _h	Min physical position D	Unsigned16
	8 _h	Max physical position D	Unsigned16
	9 _h	Actual velocity D	Integer16
	A _h	Target velocity D	Integer16
	B _h	Min velocity D due to physical limits	Integer16
	C _h	Max velocity D due to physical limits	Integer16

6.3 Pre-defined communication objects

For general definitions see /4/.

6.4 Default RPDO communication and mapping parameter

The default RPDO mapping is only a recommendation for a collimator with rectangular collimation. Variable or dynamic PDO mapping may change it.

1st RPDO communication parameter (1400_h)

The transmission type shall be 254 and the event-timer shall be 0.

1st RPDO mapping parameter (1600_h)

Object	Index	Sub-Index	Length
collimator_command	6002 _h	00 _h	08 _h
target_position_x	6010 _h	04 _h	10 _h
target_position_y	6010 _h	0E _h	10 _h

6.5 Default TPDO communication and mapping parameters

The default TPDO mapping is only a recommendation for a collimator with rectangular collimation. Variable or dynamic PDO mapping may change it.

1st TPDO communication parameter (1800_h)

The transmission type shall be 254 and the event-timer and the inhibit-timer shall be 0.

1st TPDO mapping parameter (1A00_h)

Object	Index	Sub-Index	Length
Collimator_state	6003 _h	00 _h	08 _h
actual_position_x	6010 _h	03 _h	10 _h
actual_position_y	6010 _h	0D _h	10 _h

7 Collimator object dictionary

7.1 Overview

The following objects are defined for a generic collimator and are sufficient to specify the required collimation functionality:

- Object 6000_h: Source Image Distance (SID)
- Object 6001_h: Source Fringe Distance (SFD)
- Object 6002_h: Collimator Command
- Object 6003_h: Collimator State
- Object 6010_h to 601F_h: Symmetric Rectangular_Collimation_Set_n (SRCS)
- Object 6020_h to 602F_h: Quadrangle_Collimation_Set_n (QCS)
- Object 6030_h to 603F_h: Circular_Collimation_Set_n (CCS)
- Object 6040_h to 604F_h: Homogeneous_Filter_Set_n (HFS)
- Object 6050_h to 605F_h: Spatial_Filter_Set_n (SFS)
- Object 6100_h: Visualisation_Control (VC)
- Object 6101_h: Visualisation_State (VS)
- Object 6102_h: Visualisation_Duration (VD)

Note: The manufacturer may add additional manufacturer specific objects to access manufacturer specific functionality.

7.2 6000_h: Source image distance (SID)

The SID shall be the distance between the X-ray focus and the Image Receptor Reference Plane.

VALUE DEFINITION

The value shall be given in 0.1 mm per bit.

OBJECT DESCRIPTION

INDEX	6000 _h
Name	source_image_distance
Object Code	VAR
Data Type	Unsigned16
Category	Mandatory

ENTRY DESCRIPTION

Sub-Index	0 _h
Access	rw
PDO Mapping	Optional
Value Range	0 to 50,000 _d
Default Value	No

Note: Defining the SID with “rw” access is a known violation of the architectural principles (*chapter 3*).

7.3 6001_h: Source fringe distance (SFD)

The SFD shall be the distance between the X-ray focus and the Collimator Entrance Plane. The position of the Collimator Entrance Plane is manufacturer-specific.

VALUE DEFINITION

The value shall be given in 0.1 mm per bit.

OBJECT DESCRIPTION

INDEX	6001_h
Name	source_fringe_distance
Object Code	VAR
Data Type	Unsigned16
Category	Mandatory

ENTRY DESCRIPTION

Sub-Index	0 _h
Access	rw
PDO Mapping	No
Value Range	0 to 5,000 _d
Default Value	No

Note: Defining the SFD with “rw” access is a known violation of the architectural principles (*chapter 3*).

7.4 6002_h: Collimator command

Command control word for the collimator - writing to this object is equivalent to sending a command to the collimator.

VALUE DEFINITION

0 _d	No operation
1 _d	<i>Reset:</i> A command to reset the collimator
255 _d	<i>ShutDown:</i> This command shall shutdown the collimator. Depending on the implementation, the mechanical parts move to their parking position. This command shall be issued before power-off

OBJECT DESCRIPTION

INDEX	6002_h
Name	collimator_command
Object Code	VAR
Data Type	Unsigned8
Category	Optional

ENTRY DESCRIPTION

Sub-Index	0 _h
Access	wo
PDO Mapping	Default
Value Range	See value definition
Default Value	0 _d

7.5 6003_h: Collimator state

This object shall contain the current state of the collimator.

VALUE DEFINITION

See collimator FSA (*chapter 8*).

OBJECT DESCRIPTION

INDEX	6003_h
Name	collimator_state
Object Code	VAR
Data Type	Unsigned8
Category	Mandatory

ENTRY DESCRIPTION

Sub-Index	0 _h
Access	ro
PDO Mapping	Default
Value Range	See value definition
Default Value	No

7.6 6010_h to 601F_h: Symmetric rectangular collimation set n (SRCS)

In the case that a collimator limits the X-ray beam to form a rectangular image (shape) in the image receptor reference plane, the collimation parameters shall be defined by the Symmetric_Rectangular_Collimation_Set_n (SRCS), whereby n = 1 to 16. The definition of 16 separate objects allows for up to 16 individual symmetric rectangular collimation sets per collimator.

Note: The rectangular shape of the X-ray beam is traditionally formed by symmetrical movable shutters. The positions of these shutters are governed by the X and Y distances between two opposing edges of the X-ray image in the image receptor reference plane. The collimator must calculate the required positions of the shutters in order to produce the X-ray image given by X and Y.

The behavior of both the X- and Y-coordinates are governed by the coordinate Finite State Automaton as given in *chapter 8*.

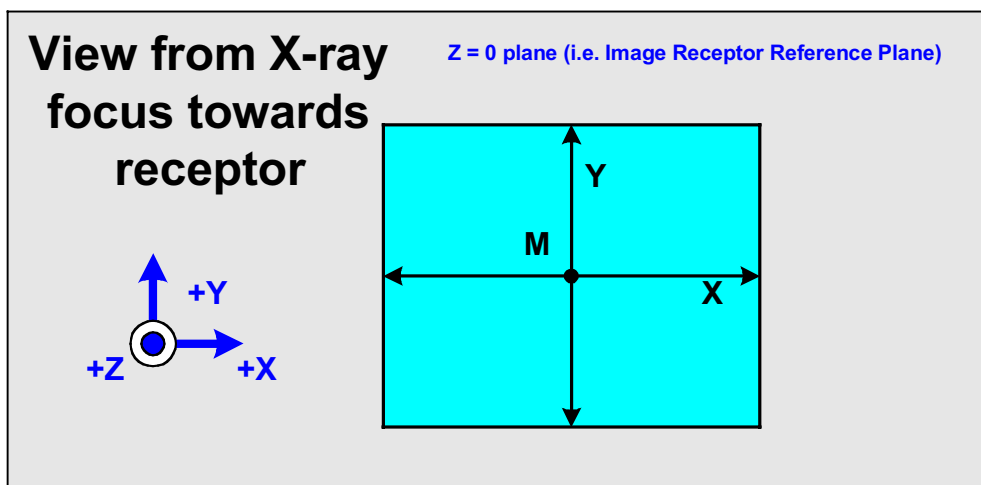

Fig. 5: Symmetric rectangular shape parameters

VALUE DEFINITION

Sub-index 1_h: The command values for coordinates Y and X are given in *chapter 6.1*.

7	4	3	0
Coordinate Y		Coordinate X	
MSB		LSB	

Sub-index 2_h:

7	6	4	3	2	0
Y <i>moving</i>	Y-coordinate FSA status		X <i>moving</i>	X-coordinate FSA status	
MSB			LSB		

- Bit 7 = 1 Y-coordinate is moving
- Bit 7 = 0 Y-coordinate is not moving
- Bit 3 = 1 X-coordinate is moving
- Bit 3 = 0 X-coordinate is not moving

The bit value definition for the Y-coordinate FSA status (bit 6, 5, and 4) and X-coordinate FSA status (Bit 2, 1 and 0) is given in *chapter 8*.

Sub-indices 3_h, 4_h, 5_h, 6_h, 7_h, 8_h, D_h, E_h, F_h, 10_h, 11_h, 12_h: The values shall be given in 0.1 mm per bit.

Sub-Indices 9_h, A_h, B_h, C_h, 13_h, 14_h, 15_h, 16_h: The values shall be given in 0.1 mm/s per bit.

OBJECT DESCRIPTION

INDEX	6010_h to 601F_h
Name	symmetric_rectangular_collimation_set_n ¹⁾
Object Code	RECORD
Data Type	x_y_parameter_set
Category	Optional

1) n = 1 for 6010_h, n = 2 for 6011_h to n = 16 for 601F_h

ENTRY DESCRIPTION

Sub-Index	0 _h
Description	number_of_parameters
Entry Category	Mandatory
Access	ro
PDO Mapping	No
Value Range	E _h to 16 _h
Default Value	No

Sub-Index	1 _h
Description	command
Entry Category	Mandatory
Access	rw
PDO Mapping	Optional
Value Range	See value definition
Default Value	0 (NOOP)

Sub-Index	2 _h
Description	control_status
Entry Category	Mandatory
Access	ro
PDO Mapping	Optional
Value Range	See value definition
Default Value	No

Sub-Index	3 _h
Description	actual_position_x
Entry Category	Mandatory
Access	ro
PDO Mapping	Default
Value Range	0 to +10,000 _d
Default Value	No

Sub-Index	4 _h
Description	target_position_x
Entry Category	Mandatory
Access	ro
PDO Mapping	Default
Value Range	0 to +10,000 _d
Default Value	No

Sub-Index	5 _h
Description	min_position_x
Entry Category	Mandatory
Access	rw
PDO Mapping	Optional
Value Range	0 to +10,000 _d
Default Value	No

Sub-Index	6 _h
Description	max_position_x
Entry Category	Mandatory
Access	rw
PDO Mapping	Optional
Value Range	0 to +10,000 _d
Default Value	No

Sub-Index	7 _h
Description	min_physical_position_x
Entry Category	Mandatory
Access	constant
PDO Mapping	No
Value Range	0 to +10,000 _d
Default Value	No

Sub-Index	8 _h
Description	max_physical_position_x
Entry Category	Mandatory
Access	constant
PDO Mapping	No
Value Range	0 to +10,000 _d
Default Value	No

Sub-Index	9 _h
Description	actual_velocity_x
Entry category	Optional
Access	ro
PDO Mapping	Optional
Value Range	-10,000 _d to +10,000 _d
Default Value	No

Sub-Index	A _h
Description	target_velocity_x
Entry Category	Optional
Access	rw
PDO Mapping	Optional
Value Range	-10,000 _d to +10,000 _d
Default Value	No

Sub-Index	B _h
Description	min_velocity_x
Entry Category	Optional
Access	constant
PDO Mapping	No
Value Range	0 _d to +10,000 _d
Default Value	No

Sub-Index	C _h
Description	max_velocity_x
Entry Category	Optional
Access	constant
PDO Mapping	No
Value Range	0 _d to +10,000 _d
Default Value	No

Sub-Index	D _h
Description	actual_position_y
Entry Category	Mandatory
Access	ro
PDO Mapping	Default
Value Range	0 to +10,000 _d
Default Value	No

Sub-Index	E _h
Description	target_position_y
Entry Category	Mandatory
Access	rw
PDO Mapping	Default
Value Range	0 to +10,000 _d
Default Value	No

Sub-Index	F _h
Description	min_position_y
Entry Category	Mandatory
Access	rw
PDO Mapping	Optional
Value Range	0 to +10,000 _d
Default Value	No

Sub-Index	10 _h
Description	max_position_y
Entry Category	Mandatory
Access	rw
PDO Mapping	Optional
Value Range	0 to +10,000 _d
Default Value	No

Sub-Index	11 _h
Description	min_physical_position_y
Entry Category	Mandatory
Access	Constant
PDO Mapping	No
Value Range	0 to +10,000 _d
Default Value	No

Sub-Index	12 _h
Description	max_physical_position_y
Entry Category	Mandatory
Access	Constant
PDO Mapping	No
Value Range	0 to +10,000 _d
Default Value	No

Sub-Index	13 _h
Description	actual_velocity_y
Entry category	Optional
Access	ro
PDO Mapping	Optional
Value Range	-10,000 _d to +10,000 _d
Default Value	No

Sub-Index	14 _h
Description	target_velocity_Y
Entry Category	Optional
Access	rw
PDO Mapping	Optional
Value Range	-10,000 _d to +10,000 _d
Default Value	No

Sub-Index	15 _h
Description	min_velocity_y
Entry Category	Optional
Access	constant
PDO Mapping	No
Value Range	0 _d to +10,000 _d
Default Value	No

Sub-Index	16 _h
Description	max_velocity_y
Entry Category	Optional
Access	constant
PDO Mapping	No
Value Range	0 _d to +10,000 _d
Default Value	No

7.7 6020_h to 602F_h: Quadrangle collimation set n (QCS)

In the case that a collimator limits the X-ray beam to form a quadrangular image (shape) in the image receptor reference plane, the collimation parameters shall be defined by the Quadrangle_Collimation_Set_n (QCS), whereby n = 1 to 4. The definition of separate objects allows for up to 4 individual quadrangular collimation sets per collimator.

Note: The quadrangle shape of the X-ray beam can be formed by independently movable shutters. The positions of these shutters are governed by a distance and an orientation. Correspondingly each of the four sides of the X-ray beam is defined by the values (s, ω). The collimator must calculate the position of the shutters in order to produce the X-ray image given by the values (s₁₋₄, ω₁₋₄). Both s and ω are defined in the Image Receptor Reference Plane.

The behavior of both the s- and ω-coordinates are governed by the Coordinate Finite State Automaton as given in *chapter 8*.

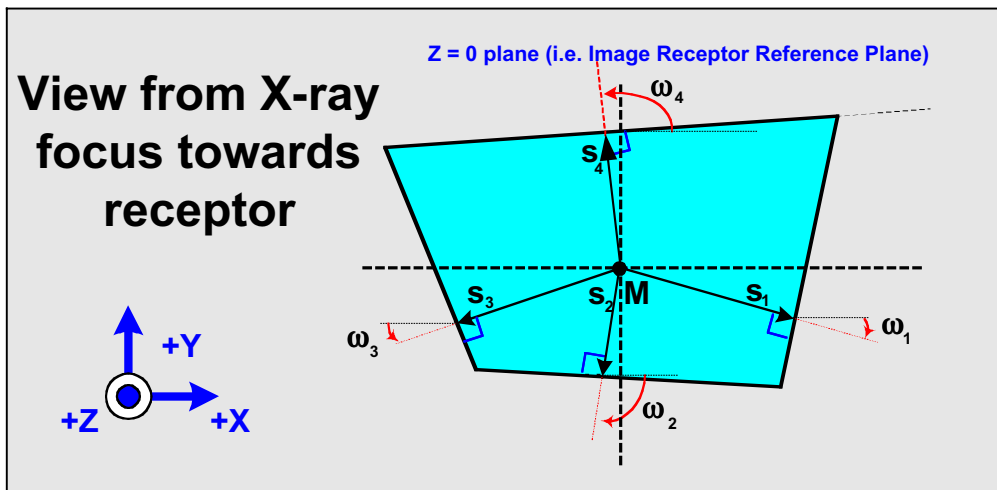

Fig. 6: Quadrangle shape parameters

- ω = Angle between the positive X-axis and the line perpendicular to respective edge of the X-ray field (see the above figure). ω is defined in the Image Receptor Reference Plane and can be positive or negative. -Turning from +X to +Y is positive.
- s = The signed distance between the origin of the collimator coordinate system (M) and the respective edge of the quadrangle collimation set (X-ray field). This implies that the line “s” representing the signed distance, is perpendicular to the shutter edge. “s” is defined in the Image Receptor Reference Plane

The distance s can be positive or negative:

- “s” is positive if the signed distance line passes the non-intercepted part of the X-ray beam.
- “s” is negative if the line passes the intercepted part of the X-ray beam.

See appendix 9.5 for more on the sign of the signed distance s .

There may be up to 4 sets defined, each of which contains 4 objects (relating to the 4 sides of the collimation set):

Set	Objects			
	Side 1	Side 2	Side 3	Side 4
1	6020 _h	6021 _h	6022 _h	6023 _h
2	6024 _h	6025 _h	6026 _h	6027 _h
3	6028 _h	6029 _h	602A _h	602B _h
4	602C _h	602D _h	602E _h	602F _h

7.7.1 6020_h: Quadrangle collimation set 1 side 1 (QCS)

This object shall define the collimation parameters for the side 1 of the quadrangular collimation function.

VALUE DEFINITION

Sub-index 1_h: The command values for coordinates ω and s are given in *chapter 6.1*.

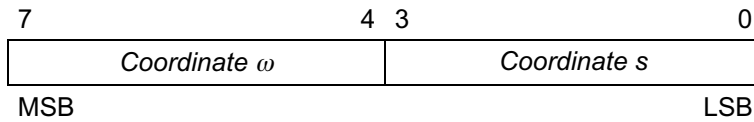

Sub-index 2_h:

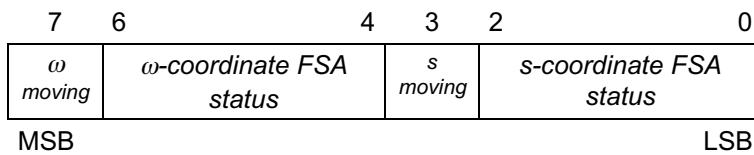

- Bit 7 = 1 ω -coordinate is moving
- Bit 7 = 0 ω -coordinate is not moving
- Bit 3 = 1 s -coordinate is moving
- Bit 3 = 0 s -coordinate is not moving

The bit value definition for the ω -coordinate FSA status (bit 6, 5, and 4) and s -coordinate FSA status (Bit 2, 1 and 0) is given in *chapter 8*.

Sub-indices 3_h, 4_h, 5_h, 6_h, 7_h, 8_h: The values shall be given in 0.1 mm per bit.

Sub-indices 9_h, A_h, B_h, C_h: The values shall be given in 0.1 mm/s per bit.

Sub-indices D_h, E_h, F_h, 10_h, 11_h, 12_h: The values shall be given in 0.1 ° per bit.

Sub-indices 13_h, 14_h, 15_h, 16_h: The values shall be given in 0.1 °/s per bit.

OBJECT DESCRIPTION

INDEX	6020 _h
Name	quadrangle_collimation_set_1_side_1
Object Code	RECORD
Data Type	s_ω_parameter_set
Category	Optional

ENTRY DESCRIPTION

Sub-Index	0 _h
Description	number_of_parameters
Entry Category	Mandatory
Access	ro
PDO Mapping	No
Value Range	E _h to 16 _h
Default Value	No

Sub-Index	1 _h
Description	command
Entry Category	Mandatory
Access	rw
PDO Mapping	Optional
Value Range	See value definition
Default Value	0 (NOOP)

Sub-Index	2 _h
Description	control_status
Entry Category	Mandatory
Access	ro
PDO Mapping	Optional
Value Range	See value definition
Default Value	No

Sub-Index	3 _h
Description	actual_position_s
Entry Category	Mandatory
Access	ro
PDO Mapping	Optional
Value Range	-10,000 _d to +10,000 _d
Default Value	No

Sub-Index	4 _h
Description	target_position_s
Entry Category	Mandatory
Access	rw
PDO Mapping	Optional
Value Range	-10,000 _d to +10,000 _d
Default Value	No

Sub-Index	5 _h
Description	min_position_s
Entry Category	Mandatory
Access	rw
PDO Mapping	Optional
Value Range	-10,000 _d to +10,000 _d
Default Value	No

Sub-Index	6 _h
Description	max_position_s
Entry Category	Mandatory
Access	rw
PDO Mapping	Optional
Value Range	-10,000 _d to +10,000 _d
Default Value	No

Sub-Index	7 _h
Description	min_physical_position_s
Entry Category	Mandatory
Access	constant
PDO Mapping	No
Value Range	-10,000 _d to +10,000 _d
Default Value	No

Sub-Index	8 _h
Description	max_physical_position_s
Entry Category	Mandatory
Access	constant
PDO Mapping	No
Value Range	-10,000 _d to +10,000 _d
Default Value	No

Sub-Index	9 _h
Description	actual_velocity_s
Entry Category	Optional
Access	ro
PDO Mapping	Optional
Value Range	-10,000 _d to +10,000 _d
Default Value	No

Sub-Index	A _h
Name	target_velocity_s
Entry Category	Optional
Access	rw
PDO Mapping	Optional
Value Range	-10,000 _d to +10,000 _d
Default Value	No

Sub-Index	B _h
Description	min_velocity_s
Entry Category	Optional
Access	constant
PDO Mapping	No
Value Range	0 _d to +10,000 _d
Default Value	No

Sub-Index	C _h
Description	max_velocity_s
Entry Category	Optional
Access	constant
PDO Mapping	No
Value Range	0 _d to +10,000 _d
Default Value	No

Sub-Index	D _h
Description	actual_position_ω
Entry Category	Mandatory
Access	ro
PDO Mapping	Optional
Value Range	-3,600 _d to +3,600 _d
Default Value	No

Sub-Index	E _h
Description	target_position_ω
Entry Category	Mandatory
Access	rw
PDO Mapping	Optional
Value Range	-3,600 _d to +3,600 _d
Default Value	No

Sub-Index	F _h
Description	min_position_ω
Entry Category	Mandatory
Access	rw
PDO Mapping	Optional
Value Range	-3,600 _d to +3,600 _d
Default Value	No

Sub-Index	10 _h
Description	max_position_ω
Entry Category	Mandatory
Access	rw
PDO Mapping	Optional
Value Range	-3,600 _d to +3,600 _d
Default Value	No

Sub-Index	11 _h
Description	min_physical_position_ω
Entry Category	Mandatory
Access	constant
PDO Mapping	No
Value Range	-3,600 _d to +3,600 _d
Default Value	No

Sub-Index	12 _h
Description	max_physical_position_ω
Entry Category	Mandatory
Access	constant
PDO Mapping	No
Value Range	-3,600 _d to +3,600 _d
Default Value	No

Sub-Index	13 _h
Description	actual_velocity_ω
Entry Category	Optional
Access	ro
PDO Mapping	Optional
Value Range	-3,600 _d to +3,600 _d
Default Value	No

Sub-Index	14 _h
Description	target_velocity_ω
Entry Category	Optional
Access	rw
PDO Mapping	Optional
Value Range	-3,600 _d to +3,600 _d
Default Value	No

Sub-Index	15 _h
Description	min_velocity_ω
Entry Category	Optional
Access	constant
PDO Mapping	no
Value Range	0 _d to +3,600 _d
Default Value	No

Sub-Index	16 _h
Description	max_velocity_ω
Entry Category	Optional
Access	constant
PDO Mapping	No
Value Range	0 _d to +3,600 _d
Default Value	No

7.7.2 6021_h to 6023_h: Quadrangle collimation set 1 side 2 to 4 (QCS)

These objects shall use correspondingly the value definition, object description, and entry description as given for object 6020_h.

7.7.3 6024_h to 602F_h: Quadrangle collimation set n side 1 to 4 (QCS)

These objects shall use correspondingly the value definition, object description, and entry description as given for objects 6020_h to 6023_h.

7.8 6030_h to 603F_h: Circular collimation set n (CCS)

In the case that a collimator limits the X-ray beam to form a circular image (shape) in the image receptor reference plane, the collimation parameters shall be given by the Circular_Collimation_Set_n (CCS), for n = 1 to 16. The definition of separate objects allows for up to 16 individual circular collimation functions per collimator.

Note: The circular shape of the X-ray beam can be formed by movable shutters. The position of these shutters is governed by the parameter D, where D is the diameter of the circular area of the X-ray field in the image receptor reference plane. The collimator must calculate the position of the shutters in order to produce the X-ray image given by the value D.

The behavior of the D-coordinate is governed by the Coordinate Finite State Automaton as given in chapter 8.

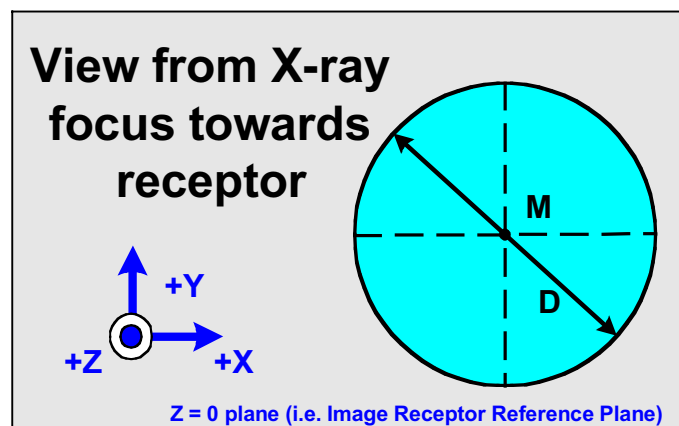

Fig. 7: Circular shape parameter

Note: The manufacturer shall specify in the relevant documentation the deviation between approximated circular collimation and the ideal circular collimation. Additionally the manufacturer shall indicate his specific definition of diameter D.

VALUE DEFINITION

Sub-index 1_h: The command values for homogenous filter are given in chapter 6.1.

7	4	3	0
Manufacturer-specific		Coordinate D	
MSB			LSB

Sub-index 2_h:

7	4	3	2	0
Manufacturer-specific		D moving	D-coordinate FSA status	
MSB				LSB

Bit 3 = 1 D-coordinate is moving
 Bit 3 = 0 D-coordinate is not moving

The bit value definition for the D-coordinate FSA status (Bit 2, 1 and 0) is given in chapter 8.

Sub-indices 3_h, 4_h, 5_h, 6_h, 7_h, 8_h: The values shall be given in 0.1 mm per bit.

Sub-indices 9_h, A_h, B_h, C_h: The values shall be given in 0.1 mm/s per bit.

OBJECT DESCRIPTION

INDEX	6030_h to 603F_h
Name	circular_collimation_set_n ¹⁾
Object Code	RECORD
Data Type	D_parameter_set
Category	Optional

1) n = 1 for 6030_h, n = 2 for 6031_h to n = 16 for 603F_h

ENTRY DESCRIPTION

Sub-Index	0 _h
Description	number_of_parameters
Entry Category	Mandatory
Access	ro
PDO Mapping	No
Value Range	8 _h to C _h
Default Value	No

Sub-Index	1 _h
Description	command
Entry Category	Mandatory
Access	rw
PDO Mapping	Optional
Value Range	See value definition
Default Value	0 (NOOP)

Sub-Index	2 _h
Description	control_status
Entry Category	Mandatory
Access	ro
PDO Mapping	Optional
Value Range	See value definition
Default Value	No

Sub-Index	3 _h
Description	actual_position_D
Entry Category	Mandatory
Access	ro
PDO Mapping	Optional
Value Range	0 to +10,000 _d
Default Value	No

Sub-Index	4 _h
Description	target_position_D
Entry Category	Mandatory
Access	rw
PDO Mapping	Optional
Value Range	0 to +10,000 _d
Default Value	No

Sub-Index	5 _h
Description	min_position_D
Entry Category	Mandatory
Access	rw
PDO Mapping	Optional
Value Range	0 to +10,000 _d
Default Value	No

Sub-Index	6 _h
Description	max_position_D
Entry Category	Mandatory
Access	rw
PDO Mapping	Optional
Value Range	0 to +10,000 _d
Default Value	No

Sub-Index	7 _h
Description	min_physical_position_D
Entry Category	Mandatory
Access	constant
PDO Mapping	No
Value Range	0 to +10,000 _d
Default Value	No

Sub-Index	8 _h
Description	max_physical_position_D
Entry Category	Mandatory
Access	constant
PDO Mapping	No
Value Range	0 to +10,000 _d
Default Value	No

Sub-Index	9 _h
Description	actual_velocity_D
Entry Category	Optional
Access	ro
PDO Mapping	Optional
Value Range	-10,000 _d to +10,000 _d
Default Value	No

Sub-Index	A _h
Description	target_velocity_D
Entry Category	Optional
Access	rw
PDO Mapping	Optional
Value Range	-10,000 _d to +10,000 _d
Default Value	No

Sub-Index	B _h
Description	min_velocity_D
Entry Category	Optional
Access	constant
PDO Mapping	no
Value Range	0 _d to +10,000 _d
Default Value	No

Sub-Index	C _h
Description	max_velocity_D
Entry Category	Optional
Access	constant
PDO Mapping	No
Value Range	0 _d to +10,000 _d
Default Value	No

7.9 Collimator filter functionality

Collimators may also provide separate controllable filters in order to affect the spectrum of the X-ray beam passing through the collimator.

7.9.1 6040_h to 604F_h: Homogeneous filter set n (HFS)

Homogeneous filters affect the complete X-ray beam. The homogeneous filter parameters shall be given by the Homogeneous_Filter_Set_n (HFS), for n = 1 to 16. The definition of separate objects allows for up to 16 individual collimation filters per collimator.

The behavior of a homogeneous filter set is governed by its Finite State Automaton (see chapter 8 "Finite State Automata").

VALUE DEFINITION

Sub-index 1_n: The command values for the homogeneous filter are given in *chapter 6.1*.

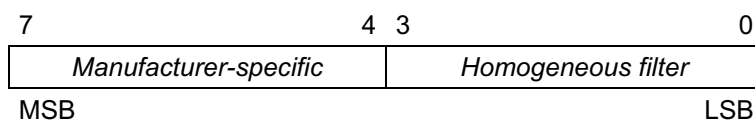

Sub-index 2_n:

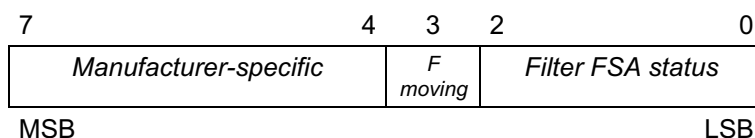

Bit 3 = 1 Filter is moving into position
 Bit 3 = 0 Filter is not moving into position

The bit value definition for the homogeneous filter FSA status (Bit 2, 1 and 0) is given in *chapter 8*.

Sub-indices 3_n, 4_n:



State
 Bit 7 = 1 Filter is not yet in requested position (not ready)
 Bit 7 = 0 Filter is in requested position

Filter type
 0 = no filter
 1_d to 127_d = manufacturer-specific

Note: The exact characteristics of the homogeneous filter are collimator-specific and shall be known to the system.

OBJECT DESCRIPTION

INDEX	6040_h to 604F_h
Name	homogeneous_filter_set_n ¹⁾
Object Code	ARRAY
Data Type	Unsigned8
Category	Optional

1) n = 1 for 6040_h, n = 2 for 6041_h to n = 16 for 604F_h

ENTRY DESCRIPTION

Sub-Index	0 _h
Description	number_of_parameters
Entry Category	Mandatory
Access	ro
PDO Mapping	No
Value Range	4 _h
Default Value	4 _h

Sub-Index	1 _h
Description	command
Entry Category	Mandatory
Access	rw
PDO Mapping	Optional
Value Range	See value definition
Default Value	0 (NOOP)

Sub-Index	2 _h
Description	control_status
Entry Description	Mandatory
Access	ro
PDO Mapping	Optional
Value Range	See value definition
Default Value	No

Sub-Index	3 _h
Description	request_homogeneous_filter
Entry Category	Mandatory
Access	rw
PDO Mapping	Optional
Value Range	See value definition
Default Value	0 (no filter)

Sub-Index	4 _h
Description	actual_homogeneous_filter
Entry Category	Mandatory
Access	ro
PDO Mapping	Optional
Value Range	See value definition
Default Value	No

7.9.2 Spatial filters

A spatial filter is a moveable filter generally used to cover a section of the X-ray beam field. The *Spatial Filter Reference Line* defines the position of the spatial filter. There may be up to 16 spatial filter units.

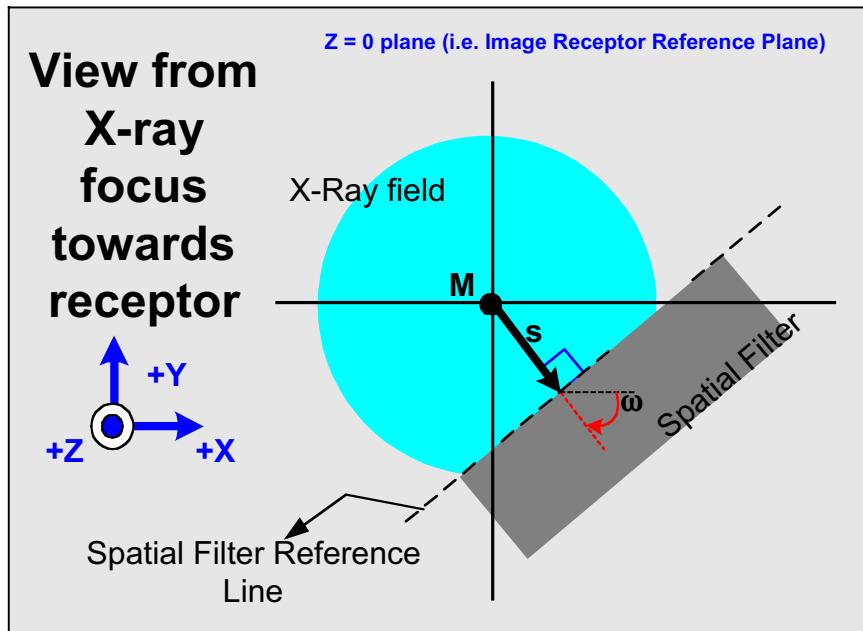

Fig. 8: Spatial filter

The position of the Spatial Filter Reference Line (see fig. 8) shall be defined by:

- ω = Angle between the positive X-axis and the line perpendicular to the *Spatial Filter Reference Line* (see the above figure). ω is defined in the Image Receptor Reference Plane and can be positive or negative. Turning from +X to +Y is positive.-
- s = The signed distance between the origin of the collimator coordinate system (M) and *Spatial Filter Reference Line*. The line "s" representing the signed distance, is perpendicular to the *Spatial Filter Reference Line*. "s" is defined in the Image Receptor Reference Plane

The distance s can be positive or negative:

- "s" is positive if the signed distance line passes the non-intercepted part of the X-ray beam.
- "s" is negative if the line passes the intercepted part of the X-ray beam.

See appendix 9.5 for more information on the sign of the signed distance s.

The behavior of both the s- and ω -coordinates are governed by the Coordinate Finite State Automaton (coordinate FSA) as given in *chapter 8*.

Note:

- The shape of the spatial filter is collimator specific (the above diagram shows a spatial filter of rectangular shape).

- The position of the Spatial filter Reference Line is dependent on the collimator and should be defined in the collimator documentation e.g. edge/middle of spatial filter. The exact mapping of the spatial filter reference line to the physical spatial filter segment is thus left to the collimator manufacturer. This includes the exact location of the centre of rotation of the segment.

7.9.2.1 6050_h to 605F_h: Spatial filter set n (SFS)

The Spatial_Filter_Set_n (SFS), whereby n = 1 to 16, may define the parameters of up to 16 spatial filters per collimator.

Note: The filter functionality is attained by positioning the spatial filter within the collimator. Its position is governed by the parameters s and ω, where s and ω are defined as above. The collimator must calculate the position of the spatial filter in order to produce the required X-ray image.

VALUE DEFINITION

Sub-index 1_h: The command values for coordinates ω and s are given in *chapter 6.1*.

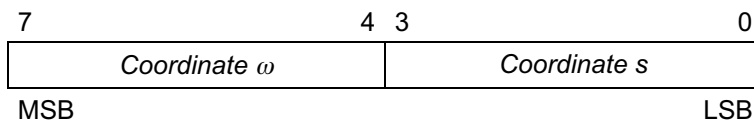

Sub-index 2_h:

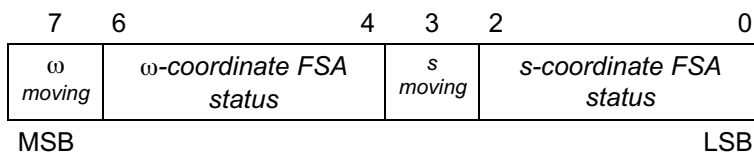

- Bit 7 = 1 ω-coordinate is moving
- Bit 7 = 0 ω-coordinate is not moving
- Bit 3 = 1 s-coordinate is moving
- Bit 3 = 0 s-coordinate is not moving

The bit value definition for the ω-coordinate FSA status (bit 6, 5, and 4) and s-coordinate FSA status (Bit 2, 1 and 0) is given in *chapter 8*.

Sub-indices 3_h, 4_h, 5_h, 6_h, 7_h, 8_h: The values shall be given in 0.1 mm per bit.

Sub-indices 9_h, A_h, B_h, C_h: The values shall be given in 0.1 mm/s per bit.

Sub-indices D_h, E_h, F_h, 10_h, 11_h, 12_h: The values shall be given in 0.1 ° per bit.

Sub-indices 13_h, 14_h, 15_h, 16_h: The values shall be given in 0.1 °/s per bit.

OBJECT DESCRIPTION

INDEX	6050_h to 605F_h
Name	spatial_filter_set_n
Object Code	RECORD
Data Type	s_ω_parameter_set
Category	Optional

1) n = 1 for 6050_h, n = 2 for 6051_h to n = 16 for 605F_h

ENTRY DESCRIPTION

Sub-Index	0 _h
Description	number_of_parameters
Entry Category	Mandatory
Access	ro
PDO Mapping	No
Value Range	E _h to 16 _h
Default Value	No

Sub-Index	1 _h
Description	command
Entry Category	Mandatory
Access	rw
PDO Mapping	Optional
Value Range	See value definition
Default Value	0 (NOOP)

Sub-Index	2 _h
Description	control_status
Entry Category	Mandatory
Access	ro
PDO Mapping	Optional
Value Range	See value definition
Default Value	No

Sub-Index	3 _h
Description	actual_position_s
Entry Category	Mandatory
Access	ro
PDO Mapping	Optional
Value Range	-10,000 _d to +10,000 _d
Default Value	No

Sub-Index	4 _h
Description	target_position_s
Entry Category	Mandatory
Access	rw
PDO Mapping	Optional
Value Range	-10,000 _d to +10,000 _d
Default Value	No

Sub-Index	5 _h
Description	min_position_s
Entry Category	Mandatory
Access	rw
PDO Mapping	Optional
Value Range	-10,000 _d to +10,000 _d
Default Value	No

Sub-Index	6 _h
Description	max_position_s
Entry Category	Mandatory
Access	rw
PDO Mapping	Optional
Value Range	-10,000 _d to +10,000 _d
Default Value	No

Sub-Index	7 _h
Description	min_physical_position_s
Entry category	Mandatory
Access	constant
PDO Mapping	No
Value Range	-10,000 _d to +10,000 _d
Default Value	No

Sub-Index	8 _h
Description	max_physical_position_s
Entry Category	Mandatory
Access	constant
PDO Mapping	No
Value Range	-10,000 _d to +10,000 _d
Default Value	No

Sub-Index	9 _h
Description	actual_velocity_s
Entry Category	Optional
Access	ro
PDO Mapping	Optional
Value Range	-10,000 _d to +10,000 _d
Default Value	No

Sub-Index	A _h
Description	target_velocity_s
Entry Category	Optional
Access	rw
PDO Mapping	Optional
Value Range	-10,000 _d to +10,000 _d
Default Value	No

Sub-Index	B _h
Description	min_velocity_s
Entry Category	Optional
Access	constant
PDO Mapping	No
Value Range	0 _d to +10,000 _d
Default Value	No

Sub-Index	C _h
Description	max_velocity_s
Entry Category	Optional
Access	constant
PDO Mapping	No
Value Range	0 _d to +10,000 _d
Default Value	No

Sub-Index	D _h
Description	actual_position_ω
Entry Category	Mandatory
Access	ro
PDO Mapping	Optional
Value Range	-3,600 _d to +3,600 _d
Default Value	No

Sub-Index	E _h
Description	target_position_ω
Entry Category	Mandatory
Access	rw
PDO Mapping	Optional
Value Range	-3,600 _d to +3,600 _d
Default Value	No

Sub-Index	F _h
Description	min_position_ω
Entry Category	Mandatory
Access	rw
PDO Mapping	Optional
Value Range	-3,600 _d to +3,600 _d
Default Value	No

Sub-Index	10 _h
Description	max_position_ω
Entry Category	Mandatory
Access	rw
PDO Mapping	Optional
Value Range	-3,600 _d to +3,600 _d
Default Value	No

Sub-Index	11 _h
Description	min_physical_position_ω
Entry Category	Mandatory
Access	constant
PDO Mapping	No
Value Range	-3,600 _d to +3,600 _d
Default Value	No

Sub-Index	12 _h
Description	max_physical_position_ω
Entry Category	Mandatory
Access	constant
PDO Mapping	No
Value Range	-3,600 _d to +3,600 _d
Default Value	No

Sub-Index	13 _h
Description	actual_velocity_ω
Entry Category	Optional
Access	ro
PDO Mapping	Optional
Value Range	-3,600 _d to +3,600 _d
Default Value	No

Sub-Index	14 _h
Description	target_velocity_ω
Entry Category	Optional
Access	rw
PDO Mapping	Optional
Value Range	-3,600 _d to +3,600 _d
Default Value	No

Sub-Index	15 _h
Description	min_velocity_ω
Entry Category	Optional
Access	constant
PDO Mapping	No
Value Range	0 _d to +3,600 _d
Default Value	No

Sub-Index	16 _h
Description	max_velocity_ω
Entry Category	Optional
Access	constant
PDO Mapping	No
Value Range	0 _d to +3,600 _d
Default Value	No

7.10 X-ray visualisation functionality

Collimators generally provide functionality to visually simulate the path of the X-ray beam and/or its radiated area, which corresponds to the examined region of interest (ROI). The following objects define the visualisation parameters.

The behaviour of the X-ray visualisation functionality is governed by the finite state automaton as given in chapter 8.

7.10.1 6100_h: Visualisation control (VC)

This object shall switch the X-ray beam visualisation function on and off. The Control bit (C-Bit) shall start and stop the visualisation function. The Trigger bit (T-Bit) shall start the X-ray beam visualisation for a period of time as given by the object Visualisation_Duration (VD).

VALUE DEFINITION

7	2	1	0
<i>Reserved (0_h)</i>		<i>T</i>	<i>C</i>
MSB		LSB	

- C = 0 visualisation is off
- C = 1 visualisation is on
- T = 0 trigger is off
- T = 1 trigger is on

OBJECT DESCRIPTION

INDEX	6100_h
Name	visualisation_control
Object Code	VAR
Data Type	Unsigned8
Category	Mandatory

ENTRY DESCRIPTION

Sub-Index	0 _h
Access	rw
PDO Mapping	Optional
Value Range	See value definition
Default Value	0 _h

7.10.2 6101_h: Visualisation state (VS)

This object shall provide the current state of the visualisation function.

VALUE DEFINITION

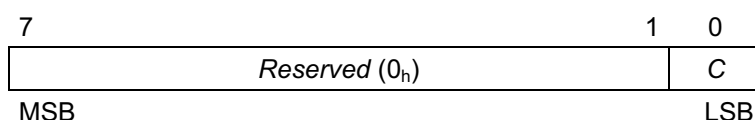

C = 0 visualisation is off

C = 1 visualisation is on

OBJECT DESCRIPTION

INDEX	6101_h
Name	visualisation_state
Object Code	VAR
Data Type	Unsigned8
Category	Mandatory

ENTRY DESCRIPTION

Sub-Index	0 _h
Access	ro
PDO Mapping	Optional
Value Range	See value definition
Default Value	No

7.10.2.1 6102_h: Visualisation duration (VD)

This object shall provide the time period, for which the visualisation function is switched on via the trigger bit of the object Visualisation_Control.

VALUE DEFINITION

The value shall be given in 0.1 s; a value of 0_h means duration time not used (visualisation not limited by time).

OBJECT DESCRIPTION

INDEX	6102_h
Name	visualisation_duration
Object Code	VAR
Data Type	Unsigned16
Category	Mandatory

ENTRY DESCRIPTION

Sub-Index	0 _h
Access	rw
PDO Mapping	No
Value Range	Unsigned16
Default Value	0 _h

8 Finite state automata (FSA)**8.1 Introduction to the finite state automata**

A finite state automaton (FSA) is an abstraction to describe the behavior of a black box as it can be experienced by external actuators.

The CANopen communication profile /1/ specifies a finite state automaton (FSA) for device-internal NMT slave communication states. This FSA specifies nothing about the device-specific behavior.

The “collimator FSA” specifies the behavior of a collimator. Due to the requirement that “a collimator with local control is usable even when the CAN network is not working properly”, the communication FSA and the collimator FSA are very loosely coupled.

8.2 The collimator FSA**8.2.1 The states of the collimator FSA**

The collimator FSA shall have the following states:

- Initial. [0]
- NotReady. [1]
- Ready. [2]
- Shutting Down. [3]
- Error. [7]
- Final. [0]

The numbers between [] are used in the status structure to indicate the state.

Initial

This shall be a pseudo state, indicating the start when the FSA is activated during the start-up sequence of the software in the collimator. ●

NotReady

In this state the collimator shall be not ready for application specific commands.

- The collimator performs initializing, self-test, etc.
- The collimator calibrates itself.
- The collimator sets variables to default values.
- The collimator moves shutters and filters to the default position.
- The collimator performs similar manufacturer specific actions.

Ready

In this state the collimator shall be ready for application specific commands and for local control (when implemented). When this state is entered, several parallel finite state automata shall be automatically created and started:

- For each coordinate of a collimation set an FSA controlling the behavior of that collimation function.
- For each filter set an FSA controlling the behavior of the filter set.
- An FSA controlling the behavior of the X-ray visualisation.

These FSAs are specified hereafter.

When this state is entered, then the FSAs that are defined as living inside the Ready State shall be created in their Initial States and proceed automatically.

When this state is left, then all FSAs inside the Ready State shall enter their Final States and shall be destroyed.

Shutting down

In this state, the collimator shall terminate all mechanical movements. The X-ray visualisation shall be switched off.

Error

This state shall be entered when the collimator detects a non-recoverable error, thus making the collimator inoperational. In case of a recoverable error, only the affected functionality shall become unusable; the collimator FSA shall not enter its Error state. The differentiation between recoverable and non-recoverable is manufacturer-specific.

Final

This shall be a pseudo state, indicating the end, when the FSA is destroyed due to the collimator being powered off, etc.

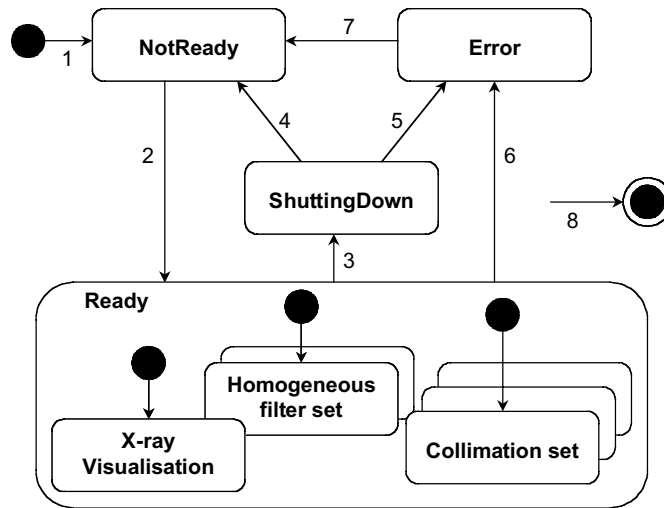

Fig.2: The collimator FSA

8.2.2 The events of the collimator FSA

The collimator FSA shall have the following events:

- Power-on or hardware reset.
- Completion of the processing in some state. This is an internal event.
- The ShutDown command received via the CAN bus.
- The Reset command received via the CAN bus.
- The detection of a non-recoverable error.

8.2.3 The transitions of the collimator FSA

The collimator FSA shall have the following transitions:

Transition	Event(s)	Action(s)
1) Initial State → NotReady State.	Due to the start-up sequence of the embedded software of the collimator, e.g. after a reset or power-on.	
2) NotReady State → Ready State.	The activities of the NotReady State have been completed without non-recoverable error.	
3) Ready State → ShuttingDown State.	The ShutDown command.	
4) ShuttingDown State → NotReady State.	All movements have been completed.	
5) ShuttingDown State → Error State.	During the activities in the ShuttingDown State a non-recoverable error occurred.	
6) Ready State → Error State.	During the activities in the Ready State a non-recoverable fault is detected or a non-recoverable error occurred.	
7) Error State → NotReady State. *)	The Reset command received via the CAN bus	
8) It's Final State	Power-off or hardware reset.	

*) The implementation of this transition is optional.

8.3 The coordinate FSA

This finite state automaton (FSA) shall be applicable for the coordinates of:

- The symmetric rectangular collimation sets
- The quadrangle collimation sets
- The circular collimation sets
- The spatial filter sets

8.3.1 The states of the coordinate FSA

The coordinate FSA shall have the following states:

- Initial. [0]
- Idle. [1]
- SystemControl. [2]
- LocalControl. [3]
- IdleLocked. [4]
- SystemControlLocked. [5]
- Error. [7]
- Final. [0]

The numbers between [] are used in the status structure to indicate the state.

Initial

This state shall indicate the creation of this FSA, performed when the collimator FSA has entered its Ready State.

Idle

In this state, the mechanics of the coordinate shall be idle, i.e., there are no movements. Commands received via the CAN bus and commands from local control may cause a mechanical movement.

SystemControl

The function shall be performing a mechanical movement as specified by a command received via the CAN bus.

LocalControl

The function shall be performing a mechanical movement as specified by a command from local control.

IdleLocked

In this state, the mechanics of the function shall be idle, i.e., there are no movements. Commands received via the CAN bus may cause a mechanical movement. Moreover, the function is locked in “system control”, i.e., local control of this coordinate is disabled.

SystemControlLocked

The function shall be performing a mechanical movement as specified by a command received via the CAN bus. Moreover, the function is locked in “system control”, i.e., local control of this coordinate is disabled.

Error

A fault has been detected or an error has occurred that shall make this coordinate unusable.

Final

This state shall indicate the destruction of this FSA, performed when the collimator FSA leaves its Ready State.

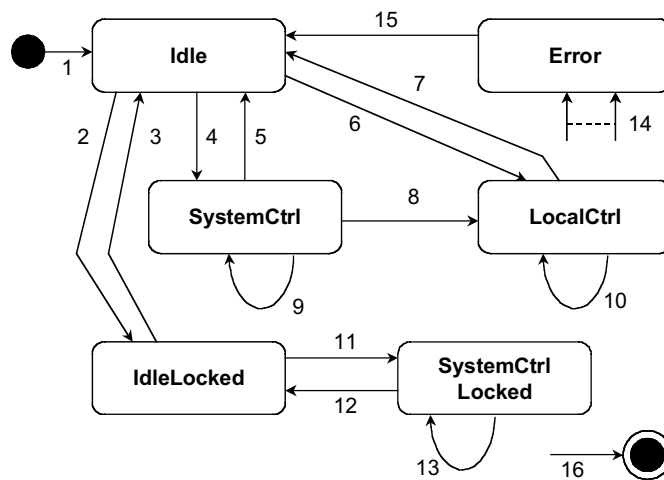

Fig. 3: The coordinate FSA

8.3.2 The events of the coordinate FSA

The coordinate FSA shall have the following events:

- Creation when the collimator FSA enters its Ready State.
- The completion of the processing in some state. These are internal events.
- The detection of a non-recoverable error.
- The Move event, i.e., when in position mode, the target position becomes not the same as the actual position of at least one of its axes. Or when in velocity mode, the target velocity of at least one of its axes becomes not zero.
Note: For the definition of position and velocity modes see section 6.
- The Stop event, i.e., one of: STOP command received, target position reached, velocity set to zero, system request limit reached, physical limit reached.
- The LOCK command received via the CAN bus.
- The UNLOCK command received via the CAN bus.
- Local control is activated. *)
- The completion of all movements caused by local control. *)
- The detection of a fault or occurrence of an error.
- The communication FSA enters the pre-operational State.

*) This event is optional. This standard does not give detail specifications. Details are manufacturer specific.

8.3.3 The transitions of the coordinate FSA

The coordinate FSA shall have the following transitions:

Transition	Event(s)	Action(s)
1) Initial State → Idle State.	Due to its creation when the collimator FSA enters it's Ready State.	
2) Idle State → IdleLocked State.	The LOCK command received.	
3) IdleLocked State → Idle State.	The UNLOCK command received. The communication FSA (NMT state machine) is in the pre-operational state ¹ .	
4) Idle State → SystemControl State.	The Move event received.	
5) SystemControl State → Idle State.	The Stop event received.	
6) Idle State → LocalControl State.	Local control has been activated (e.g. via a move command or a take local control command)	
7) LocalControl State → Idle State.	Local control has been deactivated (e.g. a local move command has been completed, local control release command has been performed)	
8) SystemControl State → LocalControl State.	Local control has been activated.	
9) SystemControl State.	The Move event received.	
10) LocalControl State.	The Move command from local control. The completion of a movement caused by local control, whereby local control remains active.	
11) IdleLocked State → SystemControlLocked State.	The Move event received.	
12) SystemControlLocked State → IdleLocked State.	The Stop event received.	
13) SystemControlLocked State.	The Move event received.	
14) Any State → Error State.	The detection of a fault or the occurrence of an error.	
15) Error State → Idle State	The Reset command.	Only when there is no pending fault. The collimator may perform manufacturer specific recovery and calibration.
16) → It's Final State.	The collimator FSA leaves its Ready State.	

8.4 The homogeneous-filter-set FSA

8.4.1 The states of the homogeneous filter FSA

The homogeneous filter FSA shall have the same states as the coordinate FSA. However, some states have a slightly different definition.

Initial

- Same -

¹ When the CAN-bus fails, then local control must be possible. Consider the scenario that the CAN-bus fails after reception of the LOCK command via the CAN-bus.

Idle

In this state, the mechanics of the filter set shall be idle, i.e., no filter changes are pending. Commands received via the CAN bus and commands from local control may cause a filter replacement.

SystemControl

The function shall be performing a filter replacement as specified by a command received via the CAN bus.

LocalControl

The function shall be performing a filter replacement as specified by a command from local control.

IdleLocked

In this state, the mechanics of the filter set shall be idle, i.e., no filter changes are pending. Commands received via the CAN bus may cause a filter replacement. Moreover, the function shall be locked in "system control", i.e., local control of this filter set is disabled.

SystemControlLocked

The function shall be performing a filter replacement as specified by a command received via the CAN bus. Moreover, the function shall be locked in "system control", i.e., local control of this filter set is disabled.

Error

A fault has been detected or an error has occurred that shall make this filter set unusable.

Final

- Same -

8.4.2 The events of the homogeneous filter FSA

The homogeneous filter FSA shall have the following events:

- Creation when the collimator FSA enters its Ready State.
- The completion of the processing in some state. These are internal events.
- The detection of a non-recoverable fault or error.
- The filter-request command, received via the CAN bus.
- The requested filter becomes in-position.
- The LOCK command received via the CAN bus.
- The UNLOCK command received via the CAN bus.
- Local control is activated or respectively a filter is requested via local control. *)
- The completion of all filter replacements caused by local control either with or without release. *)
- The detection of a fault or occurrence of an error.
- The communication FSA enters the pre-operational State.

*) This event is optional. This standard does not give detail specifications. Details are manufacturer specific.

8.4.3 The transitions of the homogeneous filter FSA

The homogeneous filter FSA shall have the following transitions:

Transition	Event(s)	Action(s)
1) Initial State → Idle State.	Due to its creation when the collimator FSA enters it's Ready State.	
2) Idle State → IdleLocked State.	The LOCK command received.	
3) IdleLocked State → Idle State.	The UNLOCK command received. The communication FSA (NMT state machine) is in the pre-operational state ² .	
4) Idle State → SystemControl State.	The filter-request command received.	
5) SystemControl State → Idle State.	The target filter is in position.	
6) Idle State → LocalControl State.	Local control has been activated (e.g. via a filter-request command from local control or a take local control command).	
7) LocalControl State → Idle State.	Local control has been deactivated (e.g. the completion of a filter replacement caused by local control)	
8) SystemControl State → LocalControl State.	Local control has been activated (e.g. via a take local control command or a filter request command from local control).	
9) SystemControl State	e.g. a filter-request command occurs before the preceding command has been completed.	
10) LocalControl State.	The filter-request command from local control. The completion of filter replacements caused by local control which do not lead to a deactivation of local control	
11) IdleLocked State → SystemControlLocked State.	The filter-request command received.	
12) SystemControlLocked State → IdleLocked State.	The completion of a filter replacement.	
13) SystemControlLocked State.	The filter-request command received.	
14) Any State → Error State.	The detection of a fault or the occurrence of an error.	
15) Error State → Idle State	The Reset command.	Only when there is no pending fault. The collimator may perform manufacturer specific recovery and calibration.
16) → It's Final State.	The collimator FSA leaves its Ready State.	

² When the CAN-bus fails, then local control must be possible. Consider the scenario that the CAN-bus fails after reception of the LOCK command via the CAN-bus.

8.5 The X-ray visualisation FSA

8.5.1 The states of the X-ray visualisation FSA

The X-ray visualisation FSA shall have the following states:

- Initial. [0]
- VisualisationOff. [1]
- VisualisationOn. [2]
- VisualisationTriggered. [3]
- Error. [7]
- Final. [0]

The numbers between [] are used in the status structure to indicate the state.

Initial

This state shall indicate the creation of this FSA, performed when the collimator FSA has entered its Ready State.

VisualisationOff

The X-ray visualisation shall be off. In this state C = 0, T = 0.

VisualisationOn

The X-ray visualisation shall be on. In this state C = 1, T = 0.

VisualisationTriggered

The X-ray visualisation shall be on. In this state C = 0, T = 1.

Error

A fault has been detected or an error has occurred that shall make this function unusable.

Final

This state shall indicate the destruction of this FSA, performed when the collimator FSA leaves its Ready State.

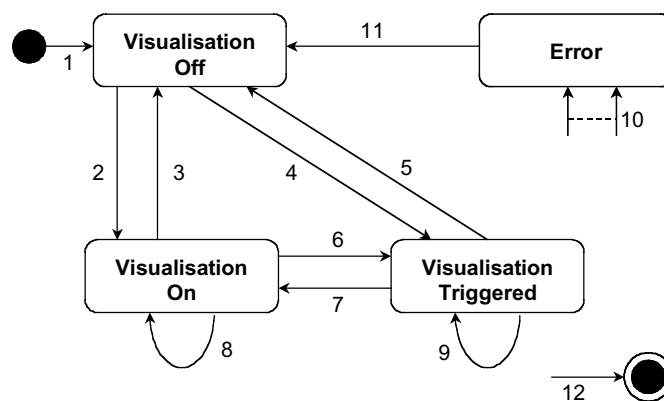

Fig. 4: The X-ray visualisation FSA

8.5.2 The events of the X-ray visualisation FSA

The X-ray visualisation FSA shall have the following events:

- Creation when the collimator FSA enters its Ready State.
- The expiration of the timer. This is an internal event.
- The commands received via the CAN bus with various values of the parameters (C, T).
- The detection of a fault or occurrence of an error.
- Local visualisation On or Off command from local control *).

Notes:

*) Local control is an option.

8.5.3 The transitions of the X-ray visualisation FSA

The X-ray visualisation FSA shall have the following transitions:

Transition	Event(s)	Action(s)
1) Initial State → VisualisationOff State.	Due to its creation when the collimator FSA enters it's Ready State.	
2) VisualisationOff → VisualisationOn.	The (C=1) command received. Local visualisationOn received.	The collimator switches the X-ray visualisation on.
3) VisualisationOn → VisualisationOff.	The (C=0, T=0) command received. Local visualisationOff received.	The collimator switches the X-ray visualisation off.
4) VisualisationOff → VisualisationTriggered.	The (C=0, T=1) command received.	The collimator switches the X-ray visualisation on and starts the timer.
5) VisualisationTriggered → VisualisationOff.	The (C=0, T=0) command received. Local visualisationOff received. The timer expires.	The collimator switches the X-ray visualisation off.
6) VisualisationOn → VisualisationTriggered.	The (C=0, T=1) command received.	The collimator starts the timer.
7) VisualisationTriggered → VisualisationOn.	The (C=1) command received.	
8) VisualisationOn.	The (C=1) command received.	
9) VisualisationTriggered.	The (C=0, T=1) command received.	The collimator restarts the timer.
10) Any state → Error State.	The detection of a fault or the occurrence of an error.	The collimator switches the X-ray visualisation off.
11) Error State → VisualisationOff State	The Reset command.	Only when there is no pending fault. The collimator may perform manufacturer specific recovery and calibration.
12) → It's Final State.	The collimator FSA leaves its Ready State.	The collimator switches the X-ray visualisation off.

9 Appendix

9.1 Collimator swivel

The definition of a collimator swivel whereby the collimator housing can be rotated with respect to the X-ray source, is not part of this device profile specification.

9.2 SID measurement

The definition of the method used to measure the SID is not a part of this device profile specification.

9.3 Patient area dose rate measurement

The definition of Patient Area Dose Rate measurement is not a part of this device profile specification.

9.4 Use case scenarios

The purpose of this chapter is to clarify the usage of the generic CANopen X-ray collimator device profile.

9.4.1 Definitions

The variable “X” is used to indicate a linear collimator blade position, as seen in the Image Receptor Reference Plane.

X_{pmin}	The minimum value of X due to a physical limit
X_{pmax}	The maximum value of X due to a physical limit
X_{pmint}	The target value of X_{pmin} . This value is the result of the (collimator internal) calculation due to a change in SID.
X_{pmaxt}	The target value of X_{pmax} . This value is the result of the (collimator internal) calculation due to a change in SID.
X_{smin}	The current minimum value of X, set by the System
X_{smax}	The current maximum value of X, set by the System
X_{smint}	The target value of X_{smin} , as set by the System
X_{smaxt}	The target value of X_{smax} , as set by the System
X_{act}	The actual value of X.
X_t	The target value of X.

Note: X_{pmint} and X_{pmaxt} are not the same as the objects `min_physical_position` and `max_physical_position` of a linear motion (coordinates *x*, *y*, *s* or *d*). These last objects describe the physical limits at SID = 1 m and are constant.

X_{pmint} and X_{pmaxt} are the actual physical limits, which are dependent on the SID and change when the SID is changed.

X_{smint} and X_{smaxt} give the minimum and maximum positions in the Image Receptor Reference Plane due to system request (coordinates *x*, *y*, *s* or *d*). These objects do not change at SID change.

9.4.2 Use case: Coordinate motion between the defined limits

In this use case, the various scenarios for coordinate motion are described. The scenarios are valid for all types of motion of the individual coordinates.

It is allowed that X_{smin}/X_{smax} are outside the physical limits. However, there are two boundary conditions.

1. The minimum system request limit is always smaller or equal to the maximum system request limit, i.e. $X_{smin} \leq X_{smax}$.
2. The system request limits always have to be set in a way that there is an intersection between system request limits and physical limits (X_{pmin} and X_{pmax}). In case the range determined by the system request limits is completely outside the range determined by the physical limits, the collimator behavior is not defined.

The following figures describe graphically the reaction of the collimator to a change in the system request limits:

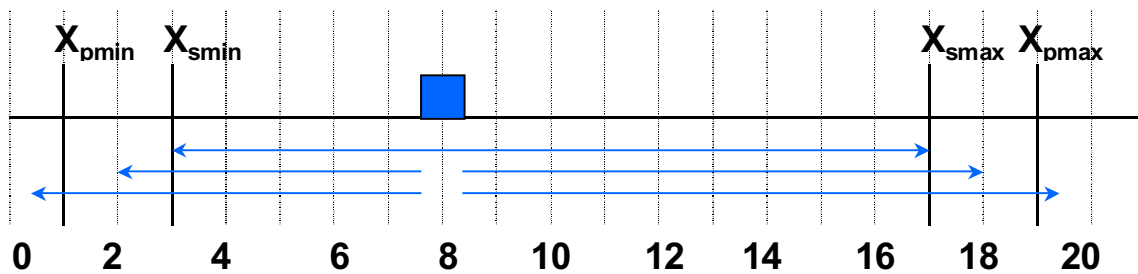

Fig. 9: The actual position is between the system request limits. No physical motion of the collimator blades occurs.

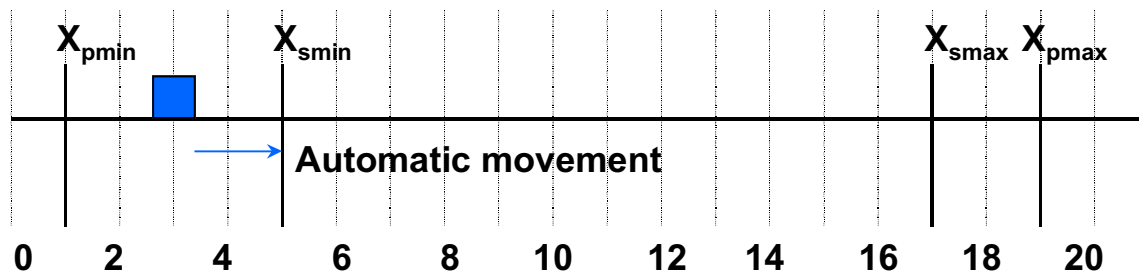

Fig. 10: The minimum system request limit has been set to the right of the actual position. The collimator blades must be moved in order to move the actual position to the minimum system request limit position.

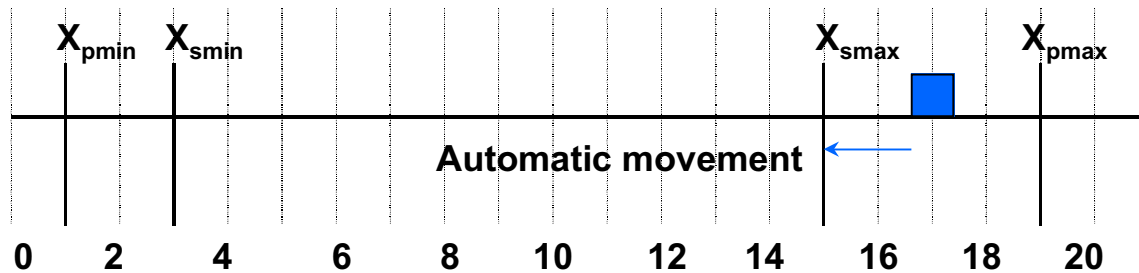

Fig. 11: The maximum system request limit has been set to the left of the actual position. The collimator blades must be moved in order to move the actual position to the maximum system request limit position.

Action: Move commands

Situation	Command	Action	Notes
$X_{smin} \leq X_{act} \leq X_{smax}$	Move to X_t with $X_{smin} \leq X_t \leq X_{smax}$	Movement to X_t	
$X_{smin} \geq X_{pmin}$	Move to X_t with $X_{pmin} \leq X_t < X_{smin}$	Movement to X_{smin}	With error message "target outside system request limit"
	Move to X_t with $X_t < X_{pmin}$	Movement to X_{smin}	With error message "target outside system request limit"
$X_{smin} < X_{pmin}$	Move to X_t with $X_{smin} \leq X_t < X_{pmin}$	Movement to X_{pmin}	With error message "target outside physical limit"
	Move to X_t with $X_t < X_{smin}$	Movement to X_{pmin}	With error message "target outside physical limit"
$X_{smax} \leq X_{pmax}$	Move to X_t with $X_{smax} < X_t \leq X_{pmax}$	Movement to X_{smax}	With error message "target outside system request limit"
	Move to X_t with $X_t > X_{pmax}$	Movement to X_{smax}	With error message "target outside system request limit"
$X_{smax} > X_{pmax}$	Move to X_t with $X_{pmax} < X_t \leq X_{smax}$	Movement to X_{pmax}	With error message "target outside physical limit"
	Move to X_t with $X_t > X_{smax}$	Movement to X_{pmax}	With error message "target outside physical limit"

Action: Set soft limits

Situation	Command	Action	Notes
	Set X_{smin} to X_{smint} with $X_{smint} \leq X_{smax}$ and $X_{smint} \leq X_{ACT}$	$X_{smin} := X_{smint}$	-
	Set X_{smin} to X_{smint} with $X_{smint} \leq X_{smax}$ and $X_{ACT} < X_{smint}$	$X_{smin} := X_{smint}$, Movement to X_{smint}	With error message "target outside system request limit"
	Set X_{smin} to X_{smint} with $X_{smint} > X_{smax}$	Reject command.	With error message "invalid data"
	Set X_{smax} to X_{smaxt} with $X_{smin} \leq X_{smaxt}$ and $X_{ACT} \leq X_{smaxt}$	$X_{smax} := X_{smaxt}$	-
	Set X_{smax} to X_{smaxt} with $X_{smin} \leq X_{smaxt}$ and $X_{smaxt} < X_{ACT}$	$X_{smax} := X_{smaxt}$, Movement to X_{smaxt}	With error message "target outside system request limit"
	Set X_{smax} to X_{smaxt} with $X_{smin} > X_{smaxt}$	Reject command.	With error message "invalid data"

9.4.3 Use case: Changes in the value of SID

It is allowed to change the SID during operation (i.e. during a period with Xray “on”). Within the limits (both physical and system request), the changes of the SID will not lead to changes in the irradiated surface (defined in the Image Receptor Reference Plane).

The influence of the SID changes can be explained as follows:

- The actual positions are defined in the Image Receptor Reference Plane. Changing the SID changes the location of the Image Receptor Reference Plane, however the actual positions remain defined in the Image Receptor Reference Plane and therefore remain unchanged.
–Physically the collimator will adapt to maintain the actual position in the Image Receptor Reference Plane –
- The system request limits are defined in the Image Receptor Reference Plane. Changing the SID changes the location of the Image Receptor Reference Plane, however the system request limits remain defined in the Image Receptor Reference Plane and therefore remain unchanged.
- The physical limits, on the other hand, are determined by the Collimator design and are fixed. The physical limits Objects are defined at SID = 1 m. Changing the SID to a value other than the default value (1 m), will therefore change the actual physical limits in the Image Receptor Reference Plane corresponding to that SID.

To summarize: When the SID changes, the collimator will:

- Compute new values of $X_{pmin} = X_{pmint}$ and $X_{pmax} = X_{pmaxt}$, and check for limit positions
- Compute the mechanical movement of the blades, necessary to keep X_{act} unchanged
- Perform this mechanical movement.

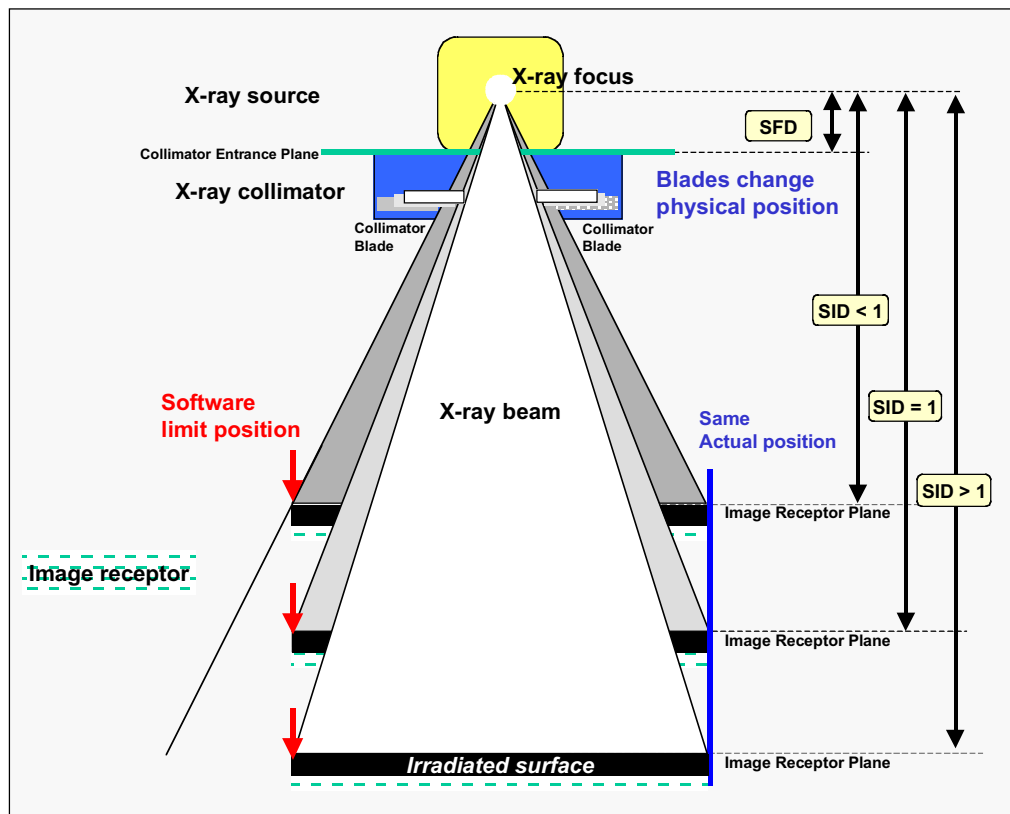

Fig. 12: Maximum system requested limits and actual positions in relation to a variable SID.

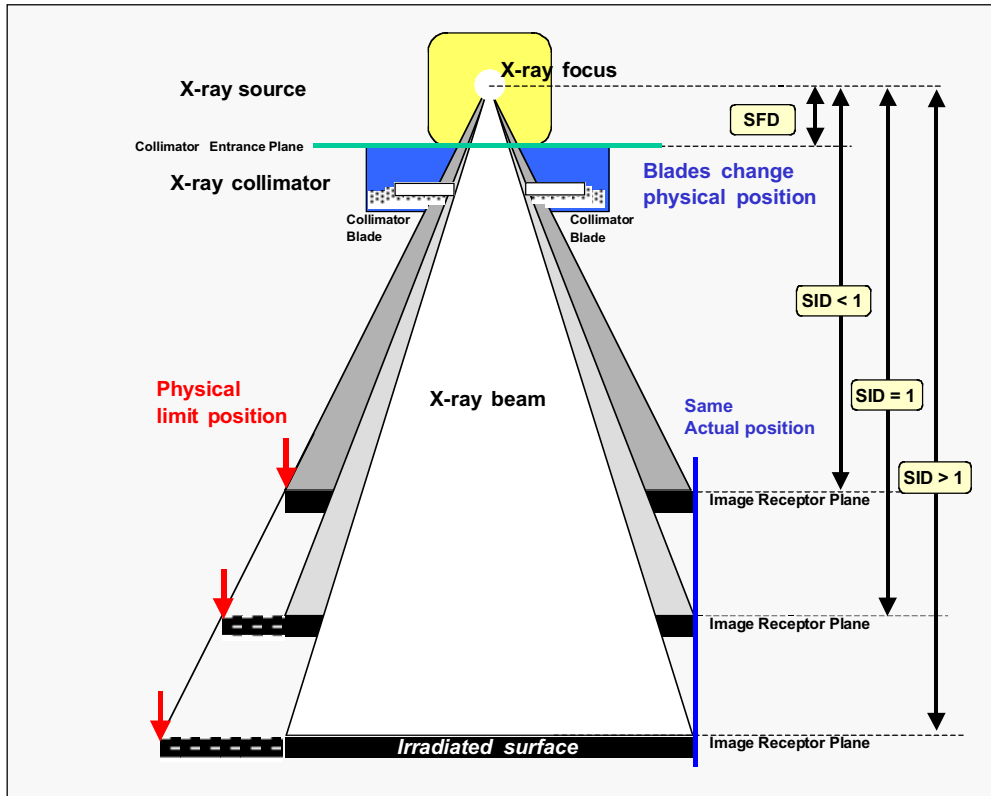

Fig. 13: Maximum physical limits and actual positions in relation to a variable SID.

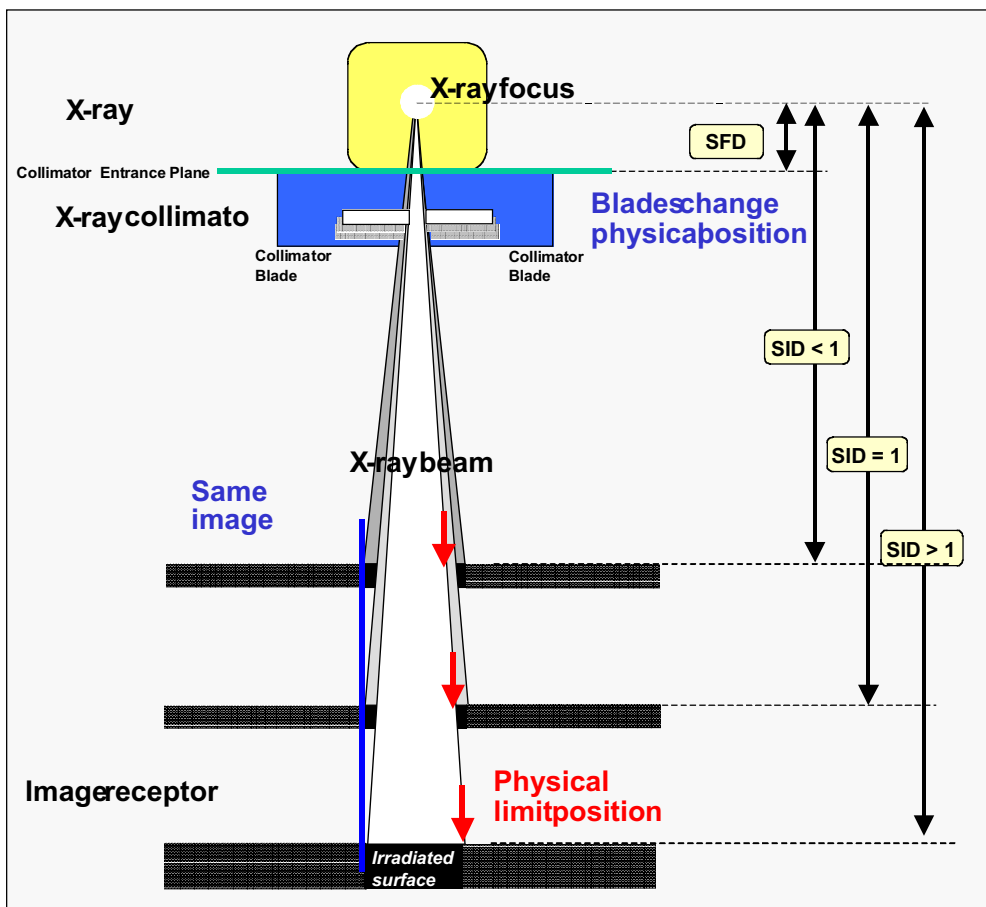

Fig. 14: Minimum physical limits and actual positions in relation to a variable SID

In the following table the scenarios for SID changes are described.

Action: Change SID

Situation	Command	Action	Notes
$X_{smin} \geq X_{pmint}$ $X_{smin} \leq X_{ACT}$	Increase SID so that X_{pmin} changes to X_{pmint}	None regarding the CANopen interface. However the collimator will physically move the blades to keep X_{act} in the image receptor reference plane	
$X_{smin} \geq X_{pmint}$ $X_{ACT} < X_{smin}$	Increase SID so that X_{pmin} changes to X_{pmint}	Movement to X_{smin}	With error message "target outside system request limit"
$X_{smin} < X_{pmint}$ $X_{pmint} \leq X_{ACT}$	Increase SID so that X_{pmin} changes to X_{pmint}	None regarding the CANopen interface. However the collimator physically moves the blades to keep X_{act} in the image receptor reference plane	
$X_{smin} < X_{pmint}$ $X_{act} < X_{pmint}$	Increase SID so that X_{pmin} changes to X_{pmint}	X_{act} is moved to X_{pmint}	With error message "target outside physical limit"
$X_{smax} \leq X_{pmaxt}$ $X_{act} \leq X_{smax}$	Decrease SID so that X_{pmax} changes to X_{pmaxt}	None regarding the CANopen interface. However the collimator physically moves the blades to keep X_{act} in the image receptor reference plane	
$X_{smax} \leq X_{pmaxt}$ $X_{smax} < X_{act}$	Decrease SID so that X_{pmax} changes to X_{pmaxt}	Movement to X_{smax}	With error message "target outside system request limit"
$X_{smax} > X_{pmaxt}$ $X_{act} \leq X_{pmaxt}$	Decrease SID so that X_{pmax} changes to X_{pmaxt}	None regarding the CANopen interface. However the collimator physically moves the blades to keep X_{act} in the image receptor reference plane	
$X_{smax} > X_{pmaxt}$ $X_{pmaxt} < X_{act}$	Decrease SID so that X_{pmax} changes to X_{pmaxt}	X_{act} is moved X_{pmaxt}	With error message "target outside physical limit"

General Warning

Since changes in system request limits or in the SID may result in mechanical movement of collimator blades (see the above use cases), they require special attention. Developers, test engineers and system integrators should be aware of the related issues.

A change of a system request limit and a change of the SID may cause a mechanical blade movement. Even when X_{act} does not change, mechanical movements cost time. While this mechanical movement is in progress, the collimator may receive further commands which would normally also result in mechanical movement, e.g. new target position, new target velocity. In such cases, the collimator must ensure that the requested collimator functionality is performed, e.g. through consecutive command performance (command queueing).

The local control of the collimator may also become active while this mechanical movement is not completed. The state change (6 or 8) corresponding to this activation must be postponed or this activation must be postponed until the mechanical movement is completed.

9.5 Coordinate systems for quadrangular collimation and spatial filters

The coordinate system used for both the quadrangular collimation set and the spatial filter set, might resemble the polar coordinate system but is in fact quite different. In order to describe the positions properly an orientation is introduced, amongst other things.

This paragraph provides some case examples to clarify the use of this coordinate system. The cases only show the spatial filter. However, the coordinate system is equally applicable to the quadrangular collimation set. For each case both the polar coordinates (r, α) as the defined coordinates (s, ω) are given.

Case 1: Move from the fourth quadrant (10% interception) to the second quadrant (90% interception) with constant orientation.

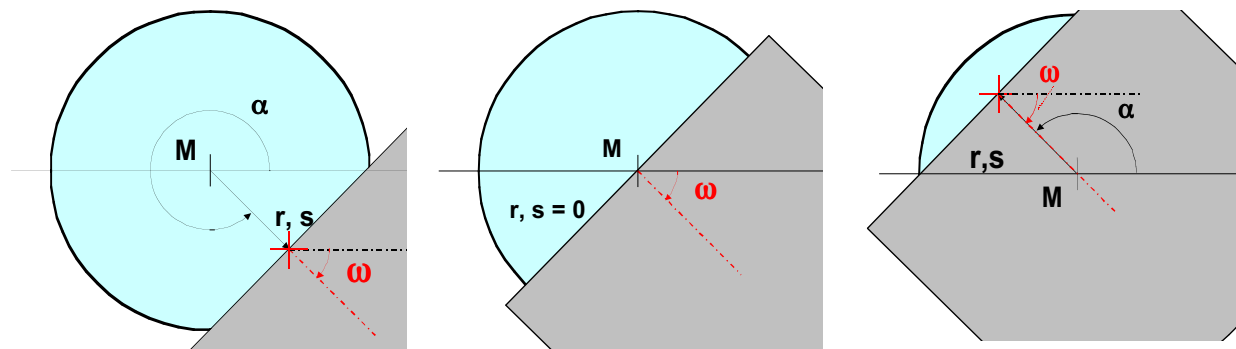

$r = 100 \text{ mm}$

$\alpha = 315^\circ$

$\omega = 315^\circ = -45^\circ$

$s = 100 \text{ mm}$

$r = 0 \text{ mm}$

$\alpha = \text{undefined, or } 0^\circ$

$\omega = 315^\circ = -45^\circ$

$s = 0 \text{ mm}$

$r = 100 \text{ mm}$

$\alpha = 135^\circ$

$\omega = 315^\circ = -45^\circ$

$s = -100 \text{ mm}$

Case 2: Rotate from the fourth quadrant via the first quadrant to the second quadrant with constant radius and always 10% interception.

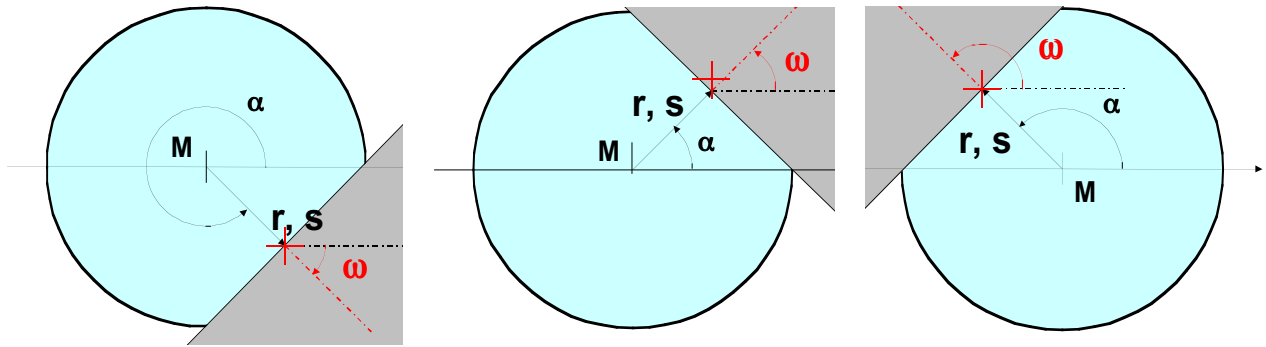

$r = 100 \text{ mm}$

$\alpha = 315^\circ$

$\omega = 315^\circ = -45^\circ$

$s = 100 \text{ mm}$

$r = 100 \text{ mm}$

$\alpha = 45^\circ$

$\omega = 45^\circ$

$s = 100 \text{ mm}$

$r = 100 \text{ mm}$

$\alpha = 135^\circ$

$\omega = 135^\circ$

$s = 100 \text{ mm}$

Case 3: Rotate from the second quadrant to the third quadrant with constant radius and always 90% interception.

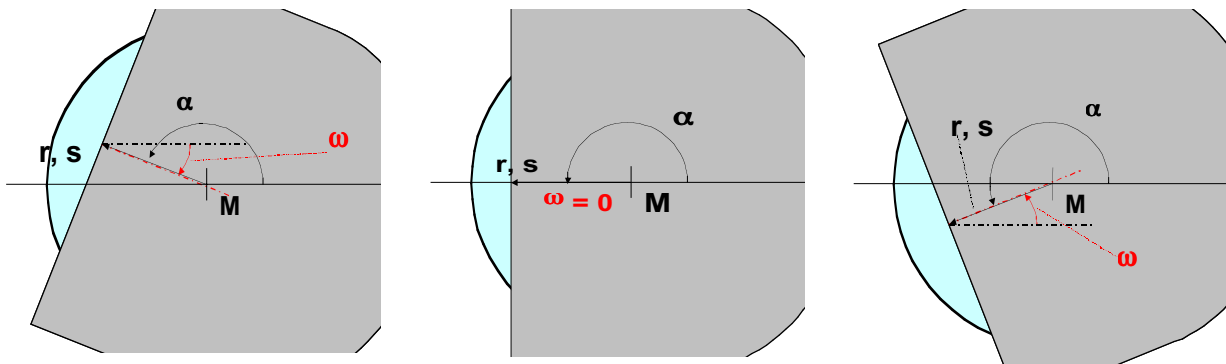

$r = 100 \text{ mm}$

$\alpha = 160^\circ$

$\omega = 340^\circ = -20^\circ$

$s = -100 \text{ mm}$

$r = 100 \text{ mm}$

$\alpha = 180^\circ$

$\omega = 0^\circ$

$s = -100 \text{ mm}$

$r = 100 \text{ mm}$

$\alpha = 200^\circ$

$\omega = 20^\circ$

$s = -100 \text{ mm}$

Case 4: Consider a narrow spatial filter, moving from the fourth quadrant (10% interception) to the second quadrant (50% interception) with constant orientation.

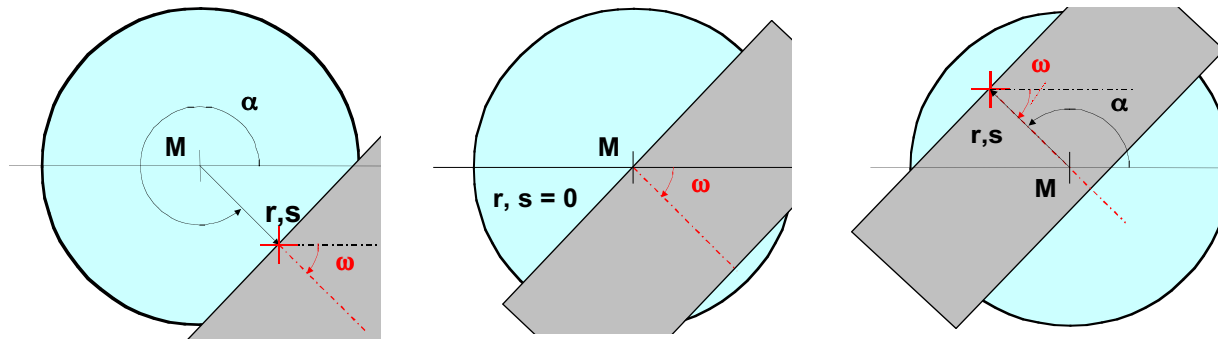

$r = 100 \text{ mm}$

$\alpha = 315^\circ$

$\omega = 315^\circ = -45^\circ$

$s = 100 \text{ mm}$

$r = 0 \text{ mm}$

$\alpha = \text{undefined, or } 0^\circ$

$\omega = 315^\circ = -45^\circ$

$s = 0 \text{ mm}$

$r = 100 \text{ mm}$

$\alpha = 135^\circ$

$\omega = 315^\circ = -45^\circ$

$s = -100 \text{ mm}$

Notes:

- This last example, where two parts of the beam are passed and the middle of the beam is intercepted, shows the exception to the general rule for the sign of "s":
 - "s" is positive if the signed distance line passes the non-intercepted part of the x-ray beam.
 - "s" is negative if the line passes the intercepted part of the x-ray beam.

In this case the manufacturer must define the plus and minus sign.